

Delta X



Counter surveillance sweeping system



User Manual

For models: Delta X 2000/6 Real-Time, Delta X G2/6, Delta X G2/12
Software version: 1.231 or newer

Content

Content.....	1
General description	3
Introduction	3
General features.....	3
Features of the new generation.....	4
Advantages.....	4
Functions of the software	5
Working modes	6
Specification	7
Supplied set.....	9
Warnings	11
Startup.....	11
Setup	11
Placement of a laptop or tablet	12
USB connections.....	14
Connection and mounting of antennas	15
Running the software.....	17
Controls and elements	18
Settings - General.....	18
Settings - Bands.....	20
Auto-Setup	20
Fields	21
Import and Export	22
Manual editing	23
Settings - Known signals.....	23
Import and export	24
Fields and controls	25
Menu	27
Status.....	27
Signals.....	27
Locator	31
Detector	32
Spectrum	34
Spectrogram.....	35
Persistence	36
Waterfall.....	37
Modes of operation.....	39
Update Masks.....	39
RF Sweep	41
Preparations	41
Initial parameters	42
Detection process.....	44
Updating mask of a known signal	45
Adjustment of the bands' thresholds.....	47
Detection distance	48
Scanning the area.....	48
Results of detection	49
Radiated Spurious Emissions.....	49
Training.....	49
Signal Analyzer	50

Spectrum	51
Demodulation.....	52
Physical locating of the transmitter	52
Directed microwave antennas MWA-6 and LPDA-12	54
Inspecting wireless bands (Wi-Fi, etc.).....	55
Adding signals to the Known Signals table.....	56
Guard 24/7	60
Reaction time	60
Initial parameters	60
Usage of 2 wideband antennas	61
Detection process.....	62
Car Tracker Detector	62
GPS trackers	62
Algorithm of detecting the periodical exchange.....	63
Location change algorithm.....	64
Stop / View Log	64
Selecting log and date	65
Viewing signals and alarms	66
Probe	68
Infrared (IR)	72
Low frequency (LF)	72
AC wires (WIRE).....	73
Low-voltage wires - Telephone, Ethernet and alarm (WIRE).....	75
Reporting.....	79
Advanced possibilities for experienced users	81
Email notifications.....	81
Setting up remote access	83
Advanced power settings.....	83
Localizing the interface	84

General description

Introduction

Welcome to the world of professional counter surveillance! The Delta X system will make your bug sweeps quick and easy, while providing extremely reliable results. The system's hardware incorporates a powerful spectrum analyzer which provides a super-fast speed of measurements with extreme sensitivity, while the built in RF "switcher" extends the system's functionality. The supplied set includes the full set of equipment needed for professional bug detection: omnidirectional antenna, directed microwave antenna, multifunction probe for checking the infrared/low frequencies and wires, cables and adapters.

Unlike conventional spectrum analyzers which require the individual inspection of each radio band depending on its assignment, the Delta X does everything automatically. The signals are recognized in the spectrum and depending on the type are saved in the "common" or "mobile & wireless" sections of the constantly updated list. Each signal is assigned an individual danger level, helping the operator to distinguish between safe external sources and suspicious local transmitters.

The great advantage of the Delta X is its high sensitivity and immunity to interference. While near-field receivers and detectors lose their sensitivity either significantly, or fully, near strong transmitters such as cellular towers, communication antennas, broadcasting stations, Wi-Fi access points, and wireless phones etc. the Delta X retains its ability to detect RF bugs at a significant distance.

The second generation of the Delta X (G2) is designed in a new portable format, which significantly eases the search process and has an extended frequency range to 12 GHz. New models mate with a laptop, or tablet, with the help of magnetic holders. They hold the laptop/tablet reliably in all situations giving the operator the ability to move and tilt the system during sweeping.

General features

- Quickly and reliably detects all kinds of RF listening devices, including analog, digital, constantly existing and intermittent, sending audio or video, with or without encryption
- Finds hidden surveillance devices employing the digital standards GSM, 3G, 4G/LTE, 5G(<6GHz) Bluetooth, Wi-Fi, DECT, etc.
- Detects illegal information transmission in AC, telephone, Ethernet, alarm and other wires as well as in the infrared range with the help of the supplied Multifunction Probe
- Can work in instant detection mode, guarding mode, locating mode and car tracker detection
- Has a 20-50 times higher sensitivity and detection distance compared to conventional RF detectors and near-field receivers
- Real-time spectrum analysis gives the ability to detect short-burst signals such as Wi-Fi, Bluetooth or mobile devices within just a few seconds
- Automatic antenna selection provides high sensitivity and detection distance on all frequency bands
- Can monitor the RF environment 24 hours a day with data logging
- Capable of detecting covert bugging devices with an accumulation function and transmitters hidden within the spectrums of other signals
- Supports storage of an unlimited quantity of signals. Full information is stored in the log and can be reviewed during the detection, or at a later time. Multiple logs are supported.
- Demodulation of audio in FM, AM, USB, LSB, CW (adjustable BW 3...240 kHz)
- Alarm relay output can activate external devices when a dangerous signal is detected (turn on a CCTV system, for example)

- Powered from the laptop's or tablet's USB

Features of the new generation

- New portable design – the device is reliably mated with the laptop or tablet and moved during the detecting and locating process
- The laptop or tablet is attached with the help of the magnetic holders
- Side handles are used for carrying
- All antennas are fixed to the main unit
- Carrying case is in the supplied set
- 2 models – up to 6 GHz or 12 GHz

Advantages

- What it is: a portable system controlled by a laptop computer or tablet
 - The high capacity of the hard drive enables full data logging during the detection (24/7 possible)
 - Wider screen is more convenient for analysis
 - Compatible with touch screens
 - Magnetic holders provide reliable attachment of the laptop/tablet to the unit while the side handles make it easy to carry the entire system
- Handling of the mobile and wireless bands GSM, CDMA, 3G, 4G/LTE, 5G(<6GHz), DECT, Wi-Fi, Bluetooth, etc.
 - Mobile and wireless signals are detected simultaneously with analog transmissions
 - Mobile/wireless signals are detected with the use of individual thresholds and are displayed separately from other signals
 - Activities within each band are stored as one signal with a certain danger level to avoid excessive records in the Signals table and to locate the sources with a hopping frequency
 - Additional sweepings on the "short-burst" bands are performed to increase the probability of interception of such signals as GSM, 3G, 4G, 5G(<6GHz), DECT, Wi-Fi, Bluetooth, etc.
 - External interference from neighboring mobile phones and Wi-Fi routers can be rejected with the help of the thresholds
 - The supplied data files allow the operator to adjust the system to the mobile/wireless bands employed in the country of use
- Sensitivity and detection distance
 - The built-in spectrum analyzer has a 20-50 times higher sensitivity and detection distance compared to conventional RF detectors and near-field receivers
 - Resistant to interference - sensitivity remains high regardless of the proximity to wireless routers, cordless phones, mobile phones, TV towers, radio broadcasting and mobile communications
- Support of the "Known signals" table
 - The operator can easily distinguish between safe and dangerous signals
 - The TV frequencies employed in the country of use can be quickly imported from the supplied data files
 - The FM, VHF/UHF police and municipal channels can be collected and stored for further use
- Advanced signal recognition method
 - The signals are automatically recognized in the spectrum traces and inserted or updated in the Signals table
 - Both analogue and digital signals are captured with an assigning of a corresponding Danger level

- Unique algorithm of measuring the signal's Danger level
 - Uses a combination of the reference trace and individual thresholds for mobile/wireless bands
 - Takes into consideration both the signal's strength and bandwidth
 - Works for both analogue and digital signals including transmissions with a changing frequency
 - Is used during the locating procedure and provides more reliable results compared to the traditional "signal strength" method.

- Low demands on the operator's level of knowledge
 - The system can be prepared for detection with the help of the "Update Masks" procedure within a few minutes
 - Manual handling of spectrum traces is not necessary
 - Everything is done automatically after the detection starts
 - The operator is warned by an audio alarm when a dangerous signal is detected

- Data logging
 - All the spectrum traces and alarms are logged during detection
 - The situation at any given time can be reviewed and studied
 - 24 hours a day logging provides detection of periodically working/remotely controlled bugging devices

- Tracking of the signal's activity
 - The full history of each separate signal, or of all signals simultaneously, is displayed on the Alarms graph
 - The events at any given time can be reviewed by simply clicking on the graph
 - The operator can see the duration of an activity and as such distinguish between any interference and real danger

- The Waterfall and Persistence graphs
 - Both the present and previous measurements at any given time can be displayed
 - The displayed time interval (density) is selectable in the range of 2 minutes to 6 hours

- Car Tracker Detector mode
 - The monitoring of mobile bands can detect signals from GPS trackers hidden within a vehicle

Functions of the software

- Rich visual representation: Spectrogram/Persistence, Waterfall, Alarms graph
- The Known Signals table allows the system to reject TV, FM and other "friendly" signals while maintaining high sensitivity to unknown signals.
- The Detector and Locator allow the operator to perform location of a bugging device with both visual and audio notification
- The Alarm Threshold decreases the false alarm rate
- The Hold Max Danger feature selects and shows the strongest signals for their location as the system is moved during detection
- The Update Mask procedure allows the operator to quickly adjust the system to the local RF environment in order to reject safe signals
- Sorting and filtering is supported in the Signals table
- The Report function allows the operator to export all obtained information about the desired signals
- Is easily localizable to any language

Working modes

- **Stop / View Log**
Review of the detection results stored in the log. The Signals table, Spectrogram, Waterfall and Alarms graph give full information about the detected signals and alarm events
- **Update masks**
Quick preparation for detection – the system automatically accumulates the broadcasting and other safe signals existing in the area in order to pass over them during the subsequent detection
- **RF Sweep**
The main detection mode. Provides maximum reaction time and the highest sensitivity. The operator can move the system or its antenna during the detection.
- **Guard 24/7**
Rejection of short transmissions and usage of two antennas reduces false alarms in this mode. Suitable for 24-hour detection without unwanted false alarms
- **Car Tracker Detector**
Detection of vehicle mounted GPS trackers transmitting the coordinates via mobile networks
- **Probe**
Checking of AC, Ethernet, Telephone and Alarm wires and the infrared/low frequency for the presence of unwanted bugging signals
- **Signal Analyzer**
Analysis, demodulation and physical locating of detected signals
- **Settings**
Includes the general settings and information about the mobile networks and wireless bands existing in the area as well as the known signals table

Specification

General

	2000/6 Real-Time	G2/6	G2/12
Frequency range	9 kHz - 6GHz	9kHz - 6 GHz	9kHz - 12 GHz
Update rate ¹	2-3 GHz/sec	2-3 GHz/sec	3-4 GHz/sec
Reaction time (How quickly a dangerous signal is detected)	2-3 sec	2-3 sec	3-4 sec
Format	Case	Handheld unit	Handheld unit
Antenna inputs	INPUT, AUX	INPUT, AUX	INPUT, AUX1, AUX2
Probe input	PROBE	PROBE	PROBE
Occupied disk space per 24 hours	< 12 Gb	< 12 Gb	< 24 Gb
Spectrum resolution	9.8 kHz		
Temperature range	0°C to +65°C		
Demands on laptop/tablet (Not included in the standard supplied set)	Intel Core i3 / AMD Ryzen 3 or higher (Intel Core i5 / AMD Ryzen 5 recommended) 1 x USB 3.0/3.1/3.2 (or USB Type C) 1 x USB 2.0 (or USB Type C) RAM 8 Gb or more SSD 128 Gb or more Windows 7, 8, 10 or newer Screen 12-14"		
Displayed dynamic range	-90...-10 dBm		
Displayed spectrum spans	0.5, 1, 2, 5, 10, 25, 50, 100, 200, 500, 1000, 2000, 3000, 6000, 12000 MHz		
Spectrum graphs	Spectrogram, Waterfall		
Spectrogram's displayed data	Persistence, Live, Max, Threshold		
Detector's modes	Wide-Range, Signal, Selection		
Updated spectrum span	RF Sweep, Guard 24/7: broadband Signal Analyzer: displayed, selected, real-time Car Tracker Detector: mobile bands		
Fields of "Signals" table	Frequency, Bandwidth, Name, dbm Level, dbm Peak Level, Danger Level, Peak Danger Level		
Fields of "Bands" table	Begin, End, Name, Type, Threshold, Priority, Tracker detection		
Fields of "Known Signals" table	Frequency, BW, Name, Modulation		

ODA-4 omnidirectional wideband antenna

- Can be used with any RF equipment, including receivers, spectrum analyzers, RF detectors, etc.
- Is capable of receiving the entire frequency range 9 kHz – 6000 MHz with increased sensitivity in the range of 80 MHz - 4000 MHz
- Connector type: SMA
- 20 or 80 cm cable
- Dimensions 20 x 3.5 x 0.6 cm
- Mode of use: receive
- Indoor use only

¹ Depends on the number of mobile and wireless bands employed in the country of use

MWA-6 microwave antenna

- Can be used with any RF equipment, including receivers, spectrum analyzers, RF detectors, etc.
- Is particularly good for the location of GSM, CDMA, 3G, 4G (LTE), 5G(<6GHz), Wi-Fi 2.4GHz, Bluetooth, Wi-Fi 5GHz, DECT and other digital transmissions
- Frequency range 800-6500 MHz
- Directed (log-periodic)
- Typical forward gain: 6 dBi
- Connector type: SMA
- 20 or 80 cm cable
- Dimensions 18 x 14.5 x 0.7 cm
- Mode of use: receive
- Indoor use only

LPDA-12 microwave antenna

- Can be used with any RF equipment, including receivers, spectrum analyzers, RF detectors, etc.
- Is particularly good for locating digital transmissions above 2GHz: 4G/LTE(2-12GHz), 5G (2-12GHz), Wi-Fi 2.4GHz, Bluetooth, Wi-Fi 5GHz; For tracing other microwave sources, including bugging devices
- Frequency range 2000-12000 MHz
- Directed (log-periodic)
- Typical forward gain: 8 dBi
- Connector type: SMA male
- Dimensions 8 x 6 x 0.7 cm
- Mode of use: receive
- Indoor use only

The Multifunction Probe

- Detects electronics emitting an electromagnetic field, infrared signals and illegal signals in 110V/220V wires (line carrier bugs, covert powerline networking), Ethernet, telephone, alarm and other low-voltage wires
- 3 channels of detection:
 - IR – infrared (built-in sensor)
 - LF - low frequency (built-in sensor)
 - WIRE - high and low-voltage wires
- Frequency range
 - IR: 9 kHz – 4 MHz
 - LF: 9 kHz – 10 MHz
 - WIRE: 9 kHz – 100 MHz
- WIRE: Max. voltage 250V (Measurement Category II)
- IR: Spectral range of sensitivity: 740 ... 1080 nm
- Direction of sensor:
 - IR: 20°
 - LF: Omni-directed 360°
- Dimensions 145 x 82 x 30 mm
- Connectors: BNC male, IEC C7 socket
- Supplied with a high voltage cable and a low voltage "alligator" cable

Supplied set

Delta X 2000/6 Real-Time

Item	2000/6 Real-Time
1. Main unit - case with the built-in spectrum analyzer and RF switcher	1
2. Software Delta X on the USB drive	1
3. ODA-4 - omnidirectional wideband antenna	1
4. MWA-6 - microwave antenna	1
5. Multifunction Probe with cables	1
6. Coaxial low-attenuation cable 5 m	1
7. In-line modular adapter	1
8. Tripod convertible to handle	1
9. Set of accessories (case's cover lock, angle USB adapters, BNC-to-SMA and SMA-to-BNC adapters)	1

1 Main unit with the built-in spectrum analyzer and RF switcher

2 Software Delta X on the USB drive



3 ODA-4 – omnidirectional wideband antenna



4 MWA-6 - microwave antenna



5 Multifunction Probe with cables



6 Coaxial low-attenuation cable 5 m



7 In-line modular adapter



8 Tripod convertible to handle



9 Set of accessories (case's cover lock, angle USB adapters, BNC-to-SMA and SMA-to-BNC adapters)



Delta X G2/6, Delta X G2/12

Item	G2/6	G2/12
1. Main unit with the built-in spectrum analyzer and RF switcher	1	1
2. Carry case	1	1
3. Software Delta X on a USB drive	1	1
4. ODA-4 - omnidirectional wideband antenna with screw and 20 cm cable	1	1
5. MWA-6 - microwave antenna with screw and 20 cm cable	1	1
6. LPDA-12 - microwave antenna (G2/12 only)	-	1
7. Multifunction Probe with cables (high-voltage cable, low-voltage cable, 2 m coaxial cable)	1	1
8. In-line modular adapter	1	1
9. Set of accessories (USB Type C to USB Type A adapter - 2, angle USB adapter - 2, magnetic stickers for laptop/tablet - 4)	1	1

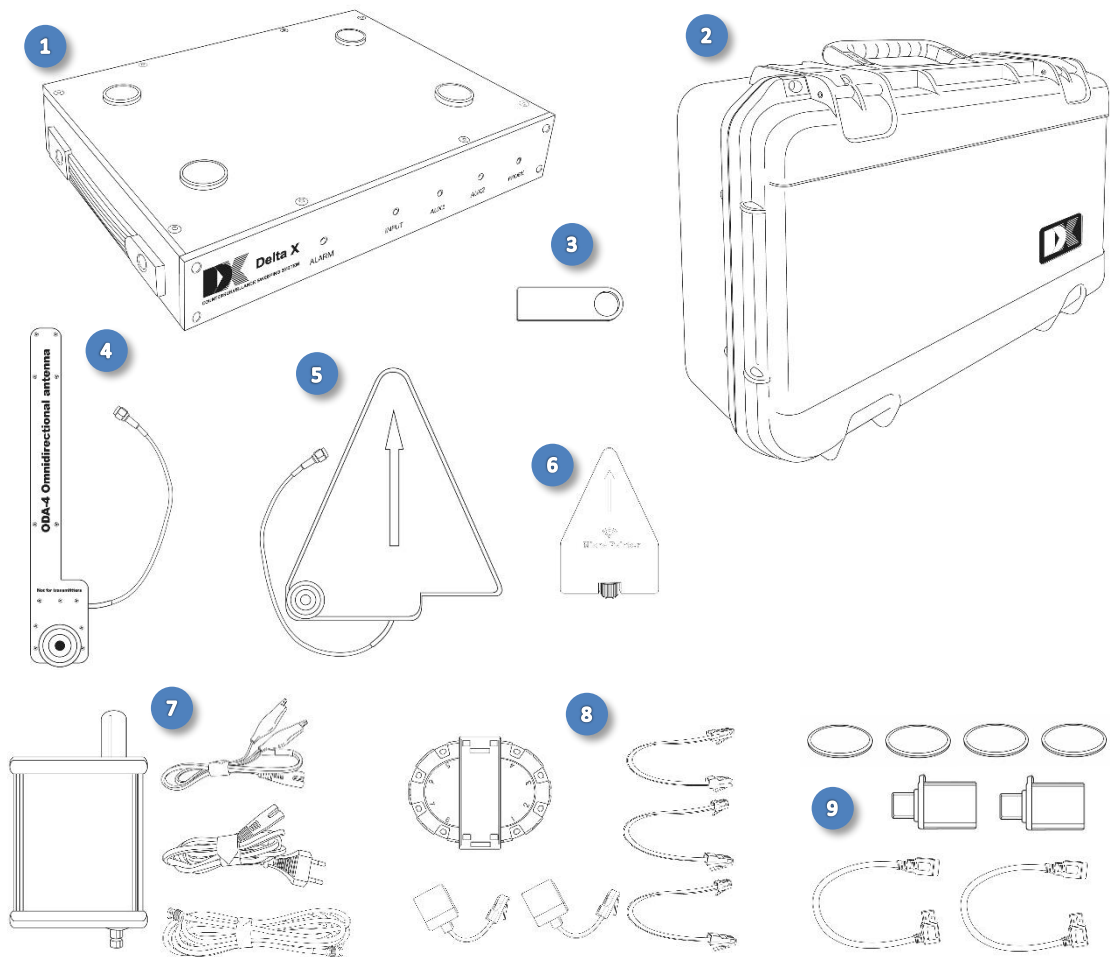

Warnings

The spectrum analyzer's input attenuator and front-end switches are sensitive to Electro-Static Discharge (ESD) and have a damage level just above +20 dBm peak. Cases of breakage due to this reason will not be accepted under the product's warranty.

Some common events which may lead to front end damage and the loss of warranty include:

- Applying more than +20 dBm peak power, such as an antenna exposed to a radar pulse or used near a signal exceeding 2 Watts (nonlinear junction detector, transceiver)
- ESD from a passive antenna, either from discharge to an antenna element, or from connecting a large antenna or cable which has built up a static charge
- Connecting to an active antenna which is already powered up

The general recommendations are:

- **Never connect any signals or outputs of active equipment directly into inputs of the system**
- **Do not use active antennas**
- **Do not turn on 2-5 Watt VHF/UHF transceivers and NLJD (nonlinear junction detectors) in a close proximity to the antenna**

Startup

Setup

Use a laptop or tablet in accordance with the specifications above. Insufficient processing power may result in unstable operation.

- Depending on the computer being used and the Windows version select the appropriate setup file on the supplied USB flash drive and run it:
 - 64 bits: Delta X Setup x64.exe (recommended)
 - 32 bits: Delta X Setup x86.exe

The Delta X software and drivers will be installed automatically.

It is strongly recommended to use the latest version of the software. It is always possible to download it using this link:

<https://sweeping-tscm.com/> (Downloads)

- Reboot the computer
- Disable all audio enhancements for the playback device in order to allow the Delta X software to produce sounds correctly:
 - Right-click the speaker icon in the system tray (near the clock)
 - Select "Playback devices"
 - Click the sound device which will be used for playback (typically "Speakers"), and then click the Properties button

- On one of the shown tabs find the checkmark responsible for the audio enhancements and disable them. Remove the checkmark if it is "Enable Audio Enhancements" or set it if you see "Disable all sound effects".
- Click OK.

Placement of a laptop or tablet

The **"2000/6 Real-Time"** model is designed in the form of a case, into which a laptop or tablet can fit. Place the laptop/tablet inside the case selecting an appropriate position depending on the location of USB sockets.

Before starting work, to prevent accidental closing of the case's cover insert the lock into the groove near the veil of the case's cover:



The newer models **"G2/12"** and **"G2/6"** are designed in the form of a portable unit which holds the laptop or tablet with the help of magnetic holders on its upper side. The counter magnets (magnetic stickers) are included in the supplied set and must be stuck to the underside of the laptop or tablet before the system is used. Once the stickers are fixed on the bottom side, the laptop or tablet can be attached to or detached from the Delta X unit when necessary.

Attaching of magnetic stickers:

1. Clean the bottom side of the laptop/tablet with an anti-grease cleaning wipe
2. Temporarily screw the ODA-4 wide-band antenna to the holder on the right side of the main unit and the MWA-6 microwave antenna to the left side. Both antennas must be positioned vertically.
3. Put your laptop or tablet on the Delta X unit, connect the power cable to it, connect the USB cables and adapters as described in section "USB connections" and find the best location for laptop/tablet keeping in mind the following suggestions:
 - The laptop or tablet should not protrude beyond the edges of the main unit
 - Protrusion of the USB cables can be minimized by shifting the laptop/tablet to the side opposite to the USB sockets
 - Interference between the cables and antennas can be avoided by shifting the laptop/tablet back-or-forth
 - If a tablet is being used make sure the Delta X magnetic holders do not interfere with the tablet's magnetic sensors of "closed cover". If the screen turns off, or a sleep

mode is entered suddenly when the tablet is on the holders, it is necessary to change the position of tablet.

- Areas on the laptop's bottom side which touch the magnets must be flat and without any legs or ventilation slots (the stickers will be fixed there). Change the position of laptop if necessary

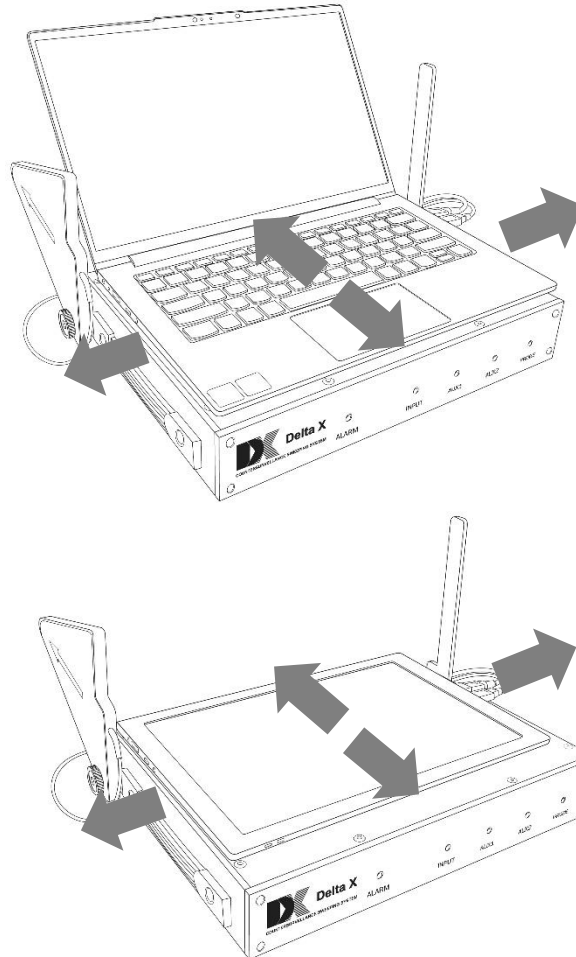

4. Remember the selected location and remove the laptop/tablet
5. Put 4 magnetic stickers on the holders with the adhesive side up and protective film removed. Align the centers
6. Keep the laptop/tablet above the main unit in the desired location, then lower and press it firmly to the stickers. Hold for a minute or two, then lift the laptop by raising its corners in turn. The stickers will be fixed to the bottom side of the laptop/tablet. Allow the glue layer to dry, and avoid multiple matings during the first 24 hours.

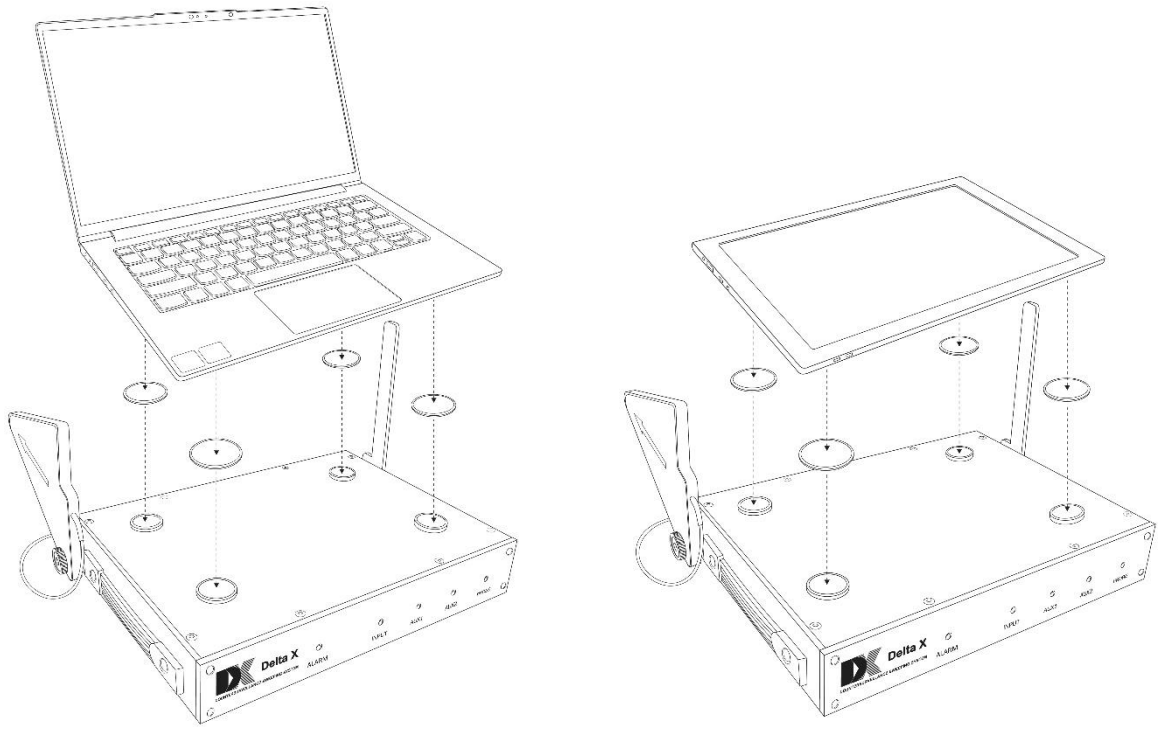

USB connections

- Connect the cables to the corresponding USB slots of the computer in accordance to the marking on the USB connectors. The main blue USB 3.0 plug can only be connected to the USB 3.0/3.1/3.2 socket, marked as “SuperSpeed” or “SS”:

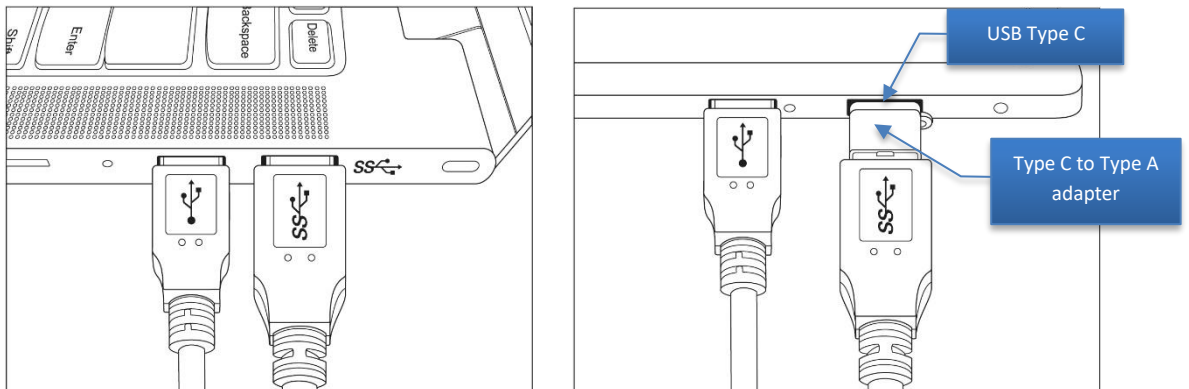

Use the adapter from the supplied set or a hub (not included in the supplied set) if your tablet or laptop does not have a Type A superspeed USB 3.X socket but instead has Type C only. The adapter or hub must support “5 Gbps” or “10 Gbps” superspeed modes:

Constantly repeated USB notification sounds (Connect – Disconnect) mean that either the USB socket, hub or adapter is incompatible with the “5 Gbps” or “10 Gbps” superspeed modes, or the device driver is not installed properly. It is possible to install the device driver separately by running the C:\Program Files\Digiscan Labs\Delta X 1.2\Driver64bit.exe program "as administrator".

- The other USB 2.0 plugs can be connected to any type of USB port
- The short cable coming out of the main blue USB plug is designed to supply additional power in case the main USB socket is not able to supply sufficient current to the device. This may happen with older laptops equipped with the first 3.0 version of USB. Modern computers usually have 3.1, 3.2 or USB Type C generations being able to provide higher current so the connection of additional powering cable is not needed.
- Use the angle USB adapters to shorten the protrusion of the connectors and avoid bending the cables

Connection and mounting of antennas

In most of modes the antennas should be connected as follows:

Connector	Antenna
INPUT	Omnidirectional wideband antenna ODA-4
AUX / AUX1	Microwave antenna MWA-6
AUX2	Microwave antenna LPDA-12 (G2/12 only)
PROBE	Multi-function Probe (the "Probe" mode only)

Delta X 2000/6 Real-Time

The recommended way of the antenna's placement is mounting them to the upper part of the case with the use of supplied screws. When using this method, the operator can easily move the Delta X system during detection and locating:



The ODA-4 antenna

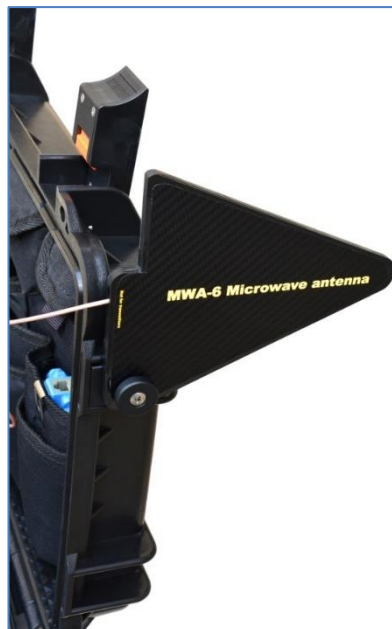

The MWA-6 antenna

Both the omnidirectional antenna ODA-4 and directed microwave antenna MWA-6 can be mounted simultaneously and connected to the INPUT and AUX correspondingly. The connectors are located on the rear side of the upper panel:

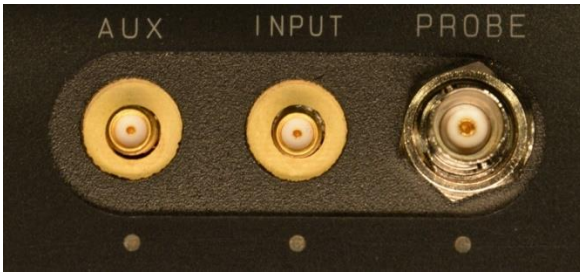

During the locating procedure the operator might need to keep the antenna in hand to probe objects and hard-to-access places more closely. For this the selected antenna can be mounted on the supplied tripod which easily converts to a handle and is connected via the 5m extension cable.

When the Delta X systems is used in a fixed position (Guard 24/7 mode) the selected antenna can be mounted on the tripod.

Delta X G2/6, Delta X G2/12

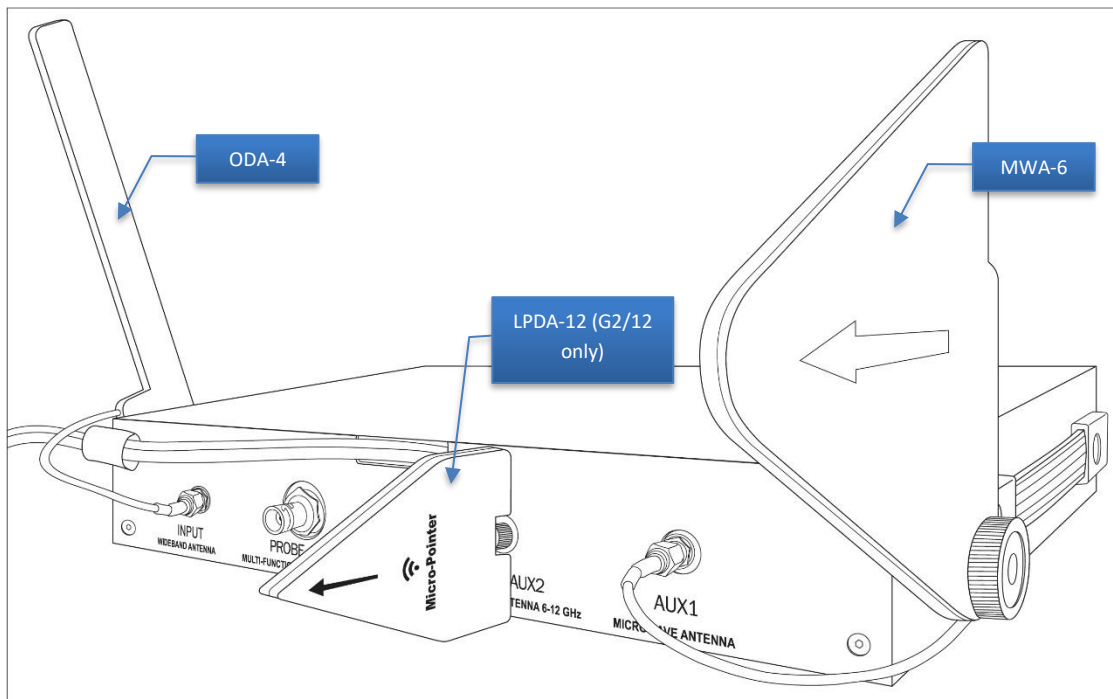

The ODA-4 wide-band antenna must be screwed vertically to the holder on the right side of the device with the help of the ¼" bolt from the supplied set. Connect the cable to the INPUT socket on the rear panel.

Screw the MWA-6 microwave antenna to the holder on the left side of the device with the help of the ¼" bolt from the supplied set. Position the antenna by its "back" and cable directed to the operator. Connect the cable to the AUX1 socket on the rear panel.

Screw the LPDA-12 antenna directly to the AUX2 socket on the rear panel of the unit (G2/12 only).

Running the software

Start the Delta X software. The startup window will appear on the screen and the procedure of finding the connected hardware will be performed.

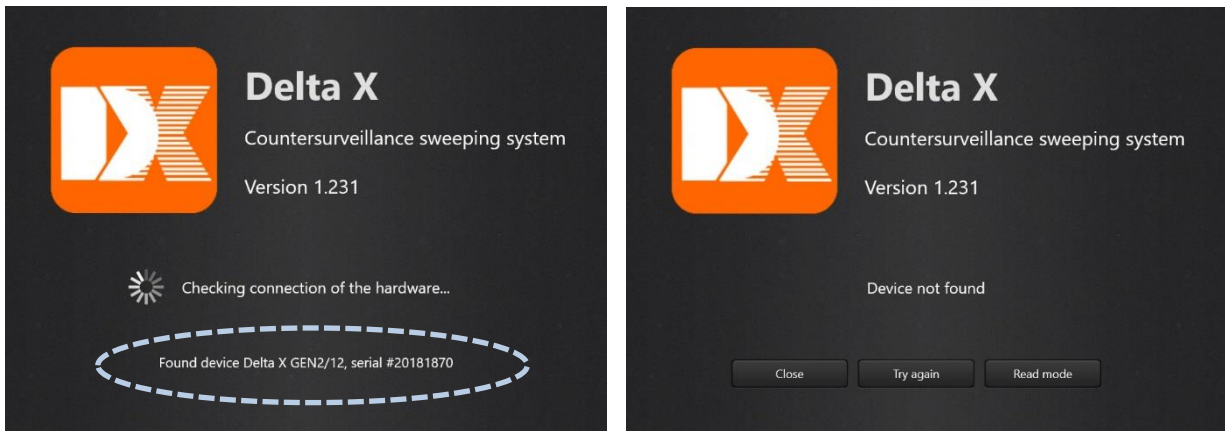

In case of detecting the Delta X equipment the "Found device" will appear and the main window will open.

Select the desired language if necessary. If the software does not display text correctly, it is necessary to change the system locale in Windows. Open the "Control Panel", make sure its content is displayed as "Small icons"; then open the "Region". Open the "Administrative" tab and press "Change system locale". Set the "Current system locale" corresponding to the language of the Delta X.

When the software is started for the first time, some required settings are missing. The application will ask the operator to perform a calibration and specify the country of use by entering the "Settings – General" automatically:

- Make sure nothing is connected to the INPUT, AUX (AUX1, AUX2) and PROBE sockets and press the "**Perform calibration**" button. The procedure will finish within a few minutes.
- The "**Location – Country**" allows the Delta X to correspond to the local frequency allocation and recognize the location's broadcasting signals. Specify the country and follow the instructions (please read the "Settings - General" section if necessary)

If there is no connection, there will be a "Device not found" message. It is possible to close the software and try again, or run in the Read mode for reviewing the logs and changing settings.

Possible reasons for the absence of connection:

- Not all USB cables are connected
- The blue USB 3.0 connector has been inserted in the incompatible USB slot (no "SS" sign)
- The powering cable is connected before the signal cable (must be connected after)
- For some reason the drivers are not installed during the software setup (can be checked in the Device Manager)
- The computer was not rebooted after the installation of the software

If any connection problems appear the device can be quickly reset by unplugging the USB cables temporarily and then connecting them again.

Controls and elements



Settings - General

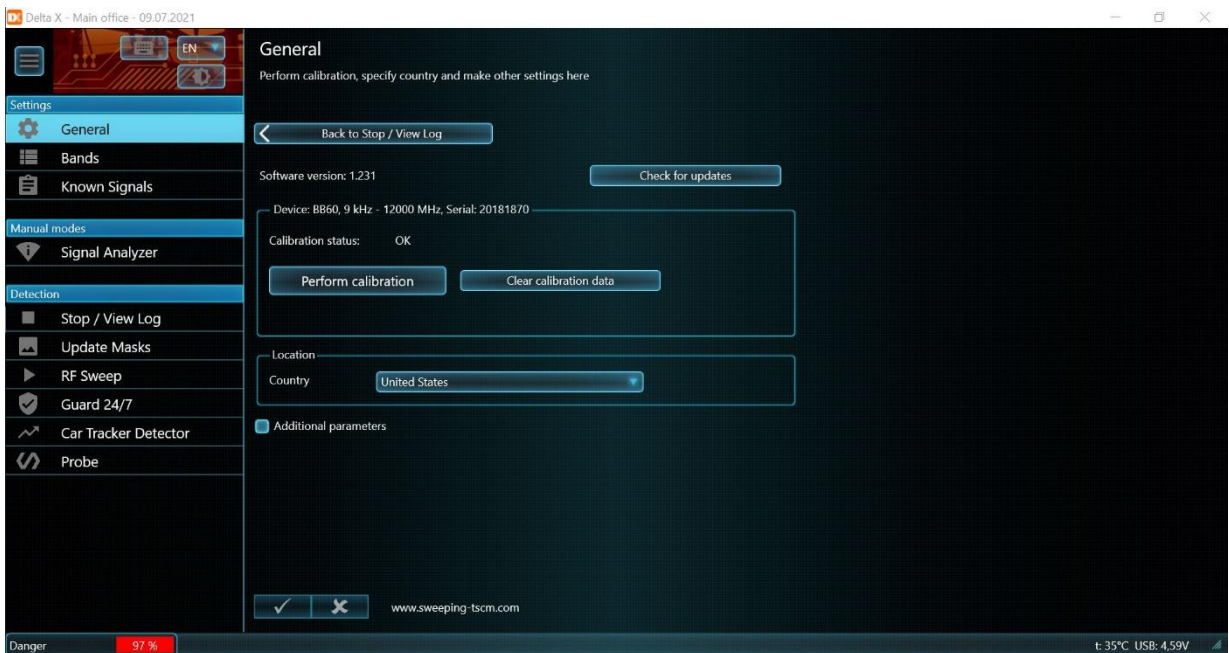

If the computer being used is online, the "**Check for updates**" button checks for the presence of newer versions on the dedicated web site and offers to download, if available. If confirmed, the Delta X software will close and downloading will commence in a default browser. It will then be necessary to find the downloaded zip file in the default "Downloads" folder, unzip it and start the setup. All logs and settings of the Delta X will stay unchanged after the update.

Calibration is needed for the compensation of the changing dynamic range on different frequencies, thus making the spectrum traces smoother and more understandable.

Perform the calibration once on each computer the system is being used on.

Make sure nothing is connected to the INPUT, AUX (AUX1, AUX2) and PROBE sockets and press the "**Perform calibration**" button. The procedure will finish within a few minutes. The antennas or probe can then be connected.

The "**Location – Country**" allows the Delta X system to know the local frequency assignment and as such to setup the mobile and wireless bands and recognize the location's broadcasting signals. After the country is selected, the software will offer to set up the Bands and clear the "Known Signals" table:

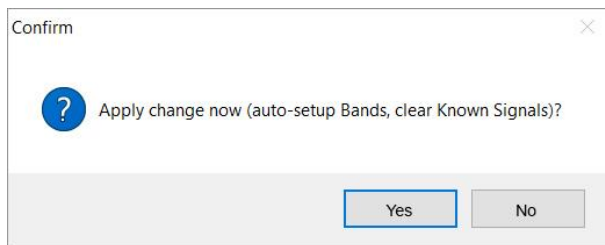

Press "Yes" to continue.

Additionally, you will be asked permission to rewrite the data in the Bands table.

Please note: since the FM and TV broadcasting frequencies might differ in the new country the Delta X software will offer to clear the Known Signals table. Press "Yes" to agree or "No" if the table contains precious information at this point and you wish to export it first.

Additional parameters

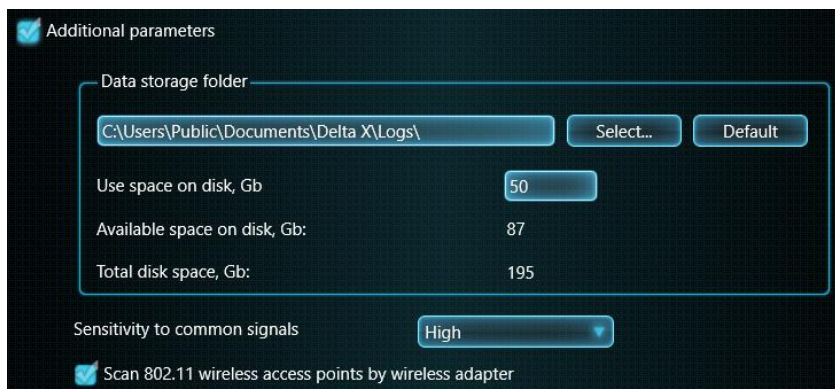

If necessary, the **data storage folder** can be changed. In the case of changing the data storage path after using the system, it is recommended to manually delete the previous folder to free up disk space.

The **"Use space on disk"** allows the operator to limit the space occupied by the logs. After reaching the limit the Delta X software will automatically delete the older logs when it is in detection mode.

Take into consideration the occupied disk space per 24 hours of detection:

	2000/6 Real-Time	G2/6	G2/12
Occupied disk space per 24 hours	11-12 Gb	11-12 Gb	22-24 Gb

If you are planning to use the Delta X system in the Guard 24/7 mode, we suggest selecting a laptop with an increased disk space. To speed up the data writing and reading we suggest using a high-speed SSD.

Please note that the logging of data during the detection may be suspended if the selected disk does not have enough free space.

"Sensitivity to common signals" determines the threshold for common signals in the detecting modes and as such affects the detection distance. With a "High" level the threshold is low so even the weakest signals are captured, here the detection distance is longest but some false detection (alarms) might be produced. With a "Moderate" level the Delta X sets the threshold in the middle so there is an optimal balance between the detection distance and false detections. "Low" sensitivity sets a higher threshold and allows the operator to minimize the alarm rate and simplify the subsequent analysis.

"Scan 802.11 wireless access points by wireless adapter" allows the system to use the computer's Wi-Fi card in order to scan for the available access points periodically and display them on the Spectrogram. This function will work if the computer is not in "flight (plane)" mode only. Please read section "Inspecting wireless bands (Wi-Fi, etc.)".

Settings - Bands

The Delta X effectively detects eavesdropping devices transmitting information via mobile networks or wireless ISM bands. For this purpose, the software handles mobile and wireless bands in a special way: all activities within each band are grouped and displayed as one signal with an individual threshold, as such the detection results do not contain excessive information; hopping signals are detected and located better while any background interference is eliminated with the help of the threshold.

Auto-Setup

The Bands table must correspond to the local frequency assignment to ensure correct detection. The Delta X is supplied with a number of data files for different countries, so after setting the country in the "Settings – General" the system offers to setup the Bands table automatically.

It can also be done later with the help of the **"Auto-Setup"** button.



Fields

The **Begin** and **End** fields are the edges of the band.

The **Name** field is obligatory and should be unique for each pair of bands, consisting of uplink and downlink.

There are the following **types** of bands:

- **Uplinks:** Used by mobile devices for sending information to base stations
- **Downlinks:** Used by base stations for sending data to the mobile devices
- **Shared frequency:** The band is used by both sides of communication simultaneously. This technology is used by some 4G/LTE/5G bands, Wi-Fi, Bluetooth, ZigBee and DECT.

The "**Threshold**" determines the sensitivity for the band. When it is exceeded by a signal, the band becomes "dangerous" and produces an alarm. The threshold allows the operator to eliminate any interference from neighboring mobile phones, Wi-Fi access points and wireless phones which cannot be switched off during the detection procedure.

Since the task of counter surveillance sweeping is detecting local signals, the thresholds for mobile devices (uplinks and shared) must be lower, while base stations (downlinks), should be rejected with the help of higher values. The thresholds can be adjusted automatically or manually.

The "**High Priority**" parameter should be set for the uplink bands of the standards which have short transmission time (timeslots). These are GSM, 3G, 4G, 5G, DECT and Wi-Fi. When fetching the spectrum trace, the Delta X system measures the priority bands longer in order to capture the short bursts.

The "**Tracker Detection**" parameter should be set for the uplinks of the mobile networks so they are scanned in the Car Tracker Detector mode.

If the "Auto-Setup" is successful, the system is ready for detection. In this case, you can skip the following sections describing the Bands in details.

Import and Export

If the "Auto-Setup" cannot find the data file for the selected country, the Bands table can be filled manually using the "**Import/Export**" button. The necessary bands should be imported from the external data files. The program has the following view when the import-export is activated:

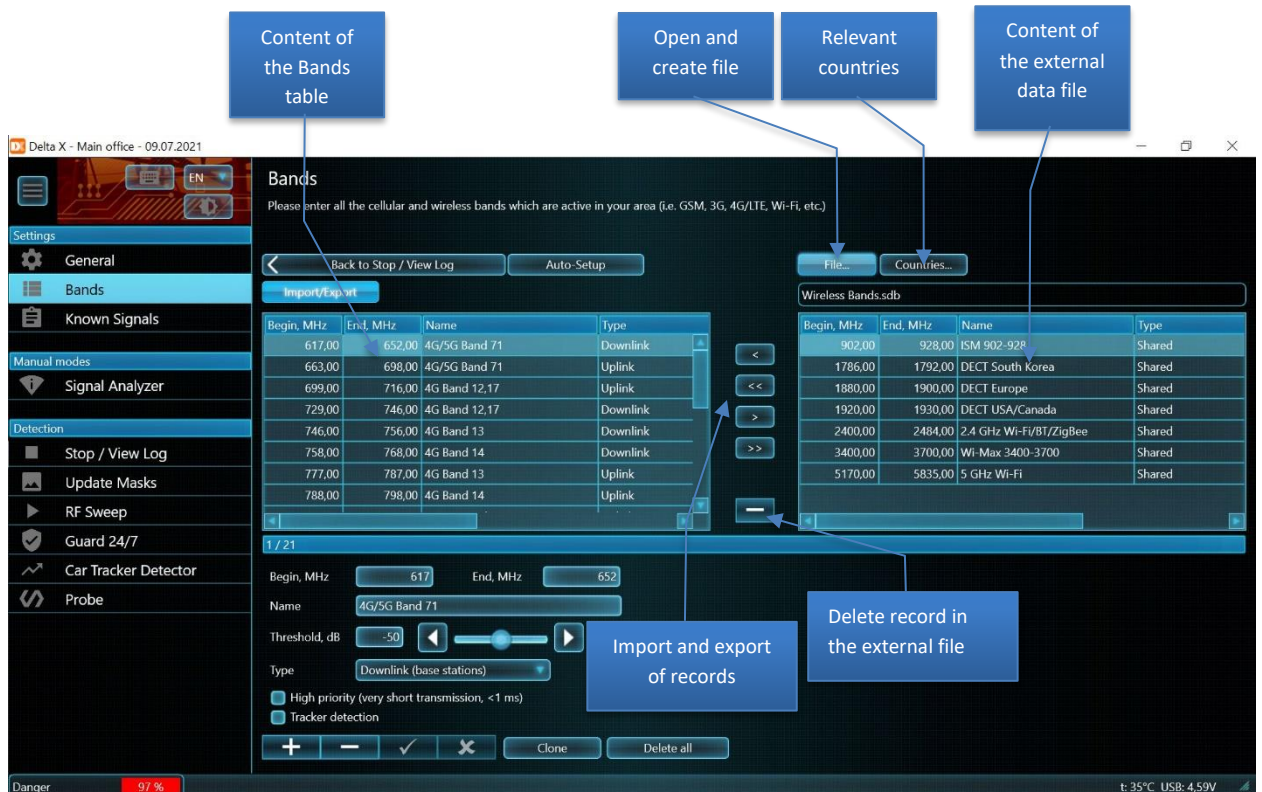

The system is supplied with the following standard data files:

- GSM Bands
- CDMA Bands
- 3G Bands
- 4G/LTE, 5G(<6GHz) bands
- Wireless Bands

To fill the Bands table for your country, first determine the frequency assignment of the mobile and wireless bands. This information might be available on the Internet or can be obtained from the local communication authorities.

- Clear the table with the help of the "**Delete All**" button
- Open the "Wireless bands" data file with the help of the "**File**" button
- Use the < button to import the necessary bands (typically: DECT, 2.4 GHz Wi-Fi/BT, 5 GHz Wi-Fi and some others)

- Open the GSM, 3G and 4G (LTE) files in turn and use the < button to import the bands which are used in your country
- **Import the assigned bands only. There cannot be overlapping bands in the Bands table**

After the Bands table is prepared its records can be exported into the external file for subsequent use:

- Press the "Import/Export" button
- Press "File", type in the new name for the data file and confirm creation of the new file
- Press >> to export all records
- Press "**Country**" and mark the country for which the file is created
- Press the "Import/Export" again to close the data file and leave the mode
- Now the "Auto-Setup" function will work if the corresponding country is selected in the "Settings – General"

Manual editing

If manual editing in the "Bands" table is needed, use the corresponding **navigation buttons Add, Delete, Apply and Discard** to add and delete records, apply and discard any changes.

"Clone" creates a copy of the current records.

The "**Delete All**" button can be used when it is necessary to clear the table before importing the new bands.

There are the following rules for bands:

- Both the uplink and downlink bands should be imported or created according to the mobile standard
- Do not create nor import the bands which are absent in your country/state
- No empty records are allowed
- No empty names are allowed. At least a short and unique description should be assigned to each pair of bands.
- No repeating of names
- Uplink and downlink's names for the same band should coincide
- The bands cannot overlap. In case of overlapping they should be combined in one record. For example, if 2 bands 1700-1750 MHz and 1700-1770 MHz are used in your country, they should be combined in one band 1700-1770 MHz.

Settings - Known signals

The Known Signals table can contain signals of radio and TV broadcasting as well as any other continuously existing signals in your area such as radio communications or wireless signals.

These can be police, federal, military, aircraft, air traffic, marine, amateur, public safety signals and wireless devices like door openers, alarm detectors, car remotes, etc.

Such signals are safe and can be met in the area many times, so saving them in the Known Signals table will speed up the process of their identification when they are detected. Known signals have a name so the operator can easily distinguish between them. The more signals that are named and saved in the Known Signals table, the fewer unknown signals are met during detection.

Because in each area (country, state or city) there might be different TV, FM and radio communication frequencies, it is recommended to clean the Known Signals table and add local frequencies again in any new area. The initial signals can be exported to an external data file and restored when necessary, as such the operator can have a separate data file for each area where a detection is performed periodically.

The screenshot displays the 'Known Signals' interface in Delta X. At the top, there are two callouts: 'Representation mode' pointing to the 'Show as' dropdown (set to 'Central frequency and bandwidth') and 'Operations with external data file' pointing to the 'Import/Export' button. A 'Content of the Known Signals table' callout points to the table below. The table contains the following data:

Frequency	BW	Name	Modulation
99	250 kHz	FM 99	FM
99,4	250 kHz	FM 99,4	FM
100	250 kHz	FM 100	FM
100,5	250 kHz	FM 100,5	FM
100,6	250 kHz	FM 100,6	FM
101,5	250 kHz	FM 101,5	FM
101,9	250 kHz	FM 101,9	FM
102,5	250 kHz	FM 102,5	FM
103,1	250 kHz	FM 103,1	FM
104	250 kHz	FM 104	FM
104,1	250 kHz	FM 104,1	FM
105	250 kHz	FM 105	FM
105,5	250 kHz	FM 105,5	FM

Below the table, the '25 / 59' indicator is visible. The input fields show: Central frequency: 103,1; Bandwidth, kHz: 250; Name: FM 103,1; Modulation: FM. The bottom control bar includes buttons for '+', '-', '<', '>', 'Clone', and 'Delete all'. A callout at the bottom maps these buttons to: 'Add record', 'Delete record', 'Apply changes', 'Discard changes', 'Clone a record', and 'Delete all records'. The status bar at the very bottom shows 'Danger 0 % Measuring' and 't: 36°C USB: 4,72V'.

The most recommended way of adding a signal into the Known Signals table is to use the "Add to Known" button after the signal is identified in the Signal Analyzer mode. It is also possible to fill the Known Signals table automatically in the Update Masks mode. The signals that are relevant for the selected country are inserted.

More details about adding signals to the Known Signal table can be read in sections "Update Masks" and "Adding signals to the Known Signals table".

Import and export

The "Import/Export" button allows the user to save the current collection of known signals into the external data file and load it back when necessary. If the Delta X is periodically used in different locations, a set of external files will help to quickly re-adjust the system each time the location is changed.

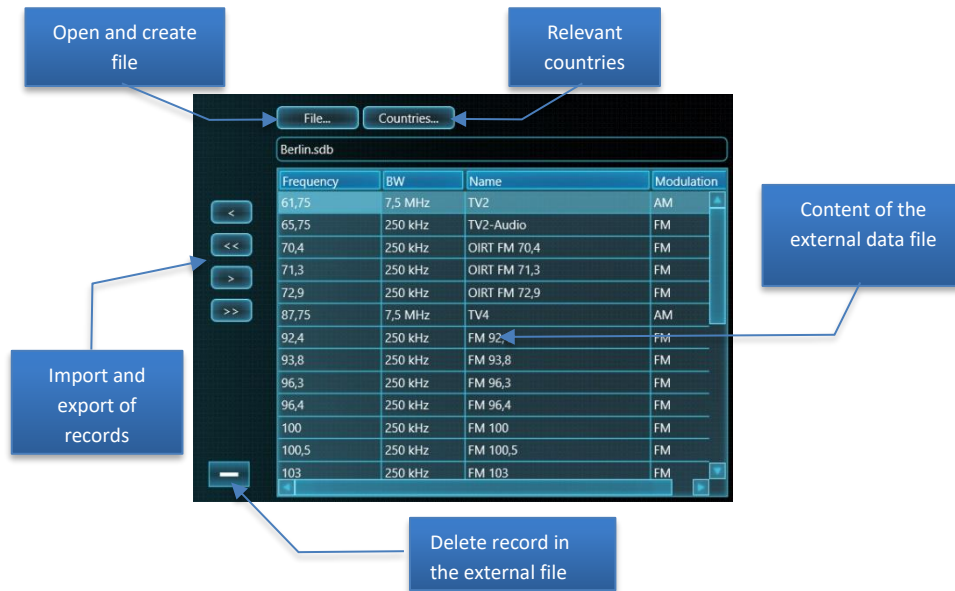

- The "File" button opens the existing file or creates a new file
- The "Countries" defines the relevant countries for the data file
- The <, <<, >, and >> buttons copy the selected record, or all records, from/to the external file

Fields and controls

The "Show As" defines the representation of signals in the table. The "Central frequency and bandwidth" mode is more convenient when editing narrowband signals, such as FM and VHF/UHF communications channels, while the "Start and finish frequency" might be more informative when working with broadband TV signals.

The "Spectrogram" allows the user to see the spectrum of the selected signal and operate its mask (drawn in blue)

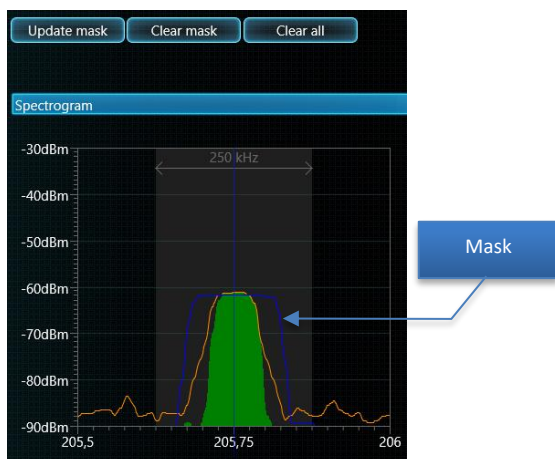

The mask repeats the signal's spectrum and helps to avoid alarms from the signal during detection. The "Update Mask" button updates the mask of the selected signal by taking values from the Max trace. The "Clear Mask" clears the mask of the selected signal. The "Clear all" clears the masks for all signals.

The navigation buttons **Add**, **Delete**, **Apply** and **Discard** allow the operator to edit the table.

The "**Clone**" button allows the operator to create a copy of the current signal, (a popup window will request some parameters):



The "**Offset, MHz**" defines the shift of the copy. This is useful for creating a list with fixed channel spacing (TV or FM frequencies for example). The "**Prefix**" is used when the name is generated from the pair "prefix" + "frequency". The "**Copies**" sets the number of created copies, each offset from the previous one. Press "**OK**" to confirm or Cancel to exit.

The "**Delete All**" button can be used when it is necessary to clear the table before filling it in the new area.

When editing the known signals follow the recommendations below:

- The name identifies the known signal, so it cannot be empty and must be unique
- The starting frequency F1 should be less than the ending frequency F2
- Known signals cannot overlap each other, or the mobile and wireless bands entered in the Bands table

Menu

The menu on the left side allows the operator to select the working mode. The menu can be **minimized and maximized** with the help of the button in the top left corner.

The **Theme (contrast mode)** allows the operator to select the convenient color scheme of the application. By default, the "dark grey" theme is selected.

The current working mode stays active when the software is in Settings so some changes can be made without interruption of the current operation.

Status

The bottom status line shows the general danger level, status of logging data, errors and warnings.

Signals

The Signals table contains the detected signals. They are recognized in the spectrum traces and inserted into the table automatically when the software is in the RF Sweep, Guard 24/7 or Car Tracker Detector mode.

There are two sections in the table: Common signals and Bands.

When the system detects activities within a mobile/wireless band, they are inserted into the Signals as a band. Other activities appearing outside the bands are inserted as common signals.

Each signal consists of the following fields:

- **Frequency** – central frequency (not displayed for bands)
- **Name** – is displayed if a common signal is present in the Known signals table or **Band name** – name of a band
- **BW** – bandwidth of a common signal or band
- **dBm** – current dBm level (green bargraph) and Peak dBm level (light green bargraph). The level is measured in the range of -90 dBm (low) ... -10 dBm (high)
- **Danger** – the current danger level (red bargraph) and the peak danger level (light red bargraph). The danger level appears when a signal exceeds the threshold and is measured between 0% and 100%. The danger reflects the strength and the bandwidth of a signal simultaneously.

Sorting "danger to the top»

Current record / total quantity of records

Signal filtering

Toolbar for Common signals

Click on a field's header to sort

Click to show and hide the toolbar

Toolbar for Bands

Current dBm level

Peak dBm level

Popup menu (can also be called by right-clicking on a signal)

Double-click a signal to see its spectrum with the displayed span readjusted

Click to scroll without changing the displayed span

Peak Danger level

Current Danger level

Frequency	Name	BW	dBm	Danger
148,7646		19,5 kHz		
391,9775		19,5 kHz		
413,374		39,1 kHz		
433,3837		58,6 kHz		
433,8818		19,5 kHz		
433,955		87,9 kHz		
446,0546		29,3 kHz		
1105,493		19,5 kHz		

Band Name	BW	dBm	Danger
CDMA850 Uplink	25 MHz		
CDMA850 Downlink	21 MHz		
P-GSM-900 Uplink	25 MHz		
DCS-1800 Uplink	73,8 MHz		
DECT	20 MHz		
3G Band 1 Uplink	60 MHz		
2.4 GHz Wi-Fi/BT/ZigBee	84 MHz		
Wi-Max 3400-3700	300 MHz		

Double-click (or press Enter) on a signal (common or band) to see its spectrum. The displayed frequency span of the spectrum graphs (Spectrogram and Waterfall) will be changed to show the signal's bandwidth fully. If the Detector is in the Signal mode, it will be assigned to the signal.

A **Click** on a signal shows it in the spectrum graphs without changing the displayed span, i.e. just scrolls to the signal. If the Detector is in the Signal mode, it will be assigned to the signal.

The **signal filtering** button allows the user to quickly select the desired signals:

- **All** – all signals are shown
- **Unknown** – only the signals absent in the Known Signals table are shown
- **Dangerous** – the signals with a Peak Danger of more than 0% are selected

The **"Danger top"** button quickly adjusts sorting of the most dangerous signals to the top.

The **"Hold Max Danger"** function automatically tunes in the most dangerous signals during detection so that the spectrum graphs and the Detector start showing the signal. Since the Detector allows the operator to carry out the locating procedure, the function is convenient for simultaneously detecting and locating. The system is moved during the detecting (RF Sweep mode). As soon as a signal is found the Detector will instantly show the danger level changing depending on the distance.

The Hold Max Danger function should be deactivated when it is necessary to scroll to and review other signals from the Signals table or other frequency ranges on the spectrum graphs. Otherwise the function will forcibly tune into the most dangerous signal again while readjusting the spectrum graphs correspondingly.

The **popup menu** contains additional commands for the signal(s). It can be called by clicking on the button shown below or by right-clicking on a signal.



The "**Selected signal - Search in other logs**" command allows the user to check other logs for the presence of a signal. RF bugging devices broadcast signals over a limited distance, so it is unlikely that they are registered in other parts of the area/city. At the same time safe signals from communications or broadcasting may be present in many places. Therefore, if you have done many sweeps in different parts of the area old logs can be used for additional identification of unknown signals.

The log selection window will pop up:

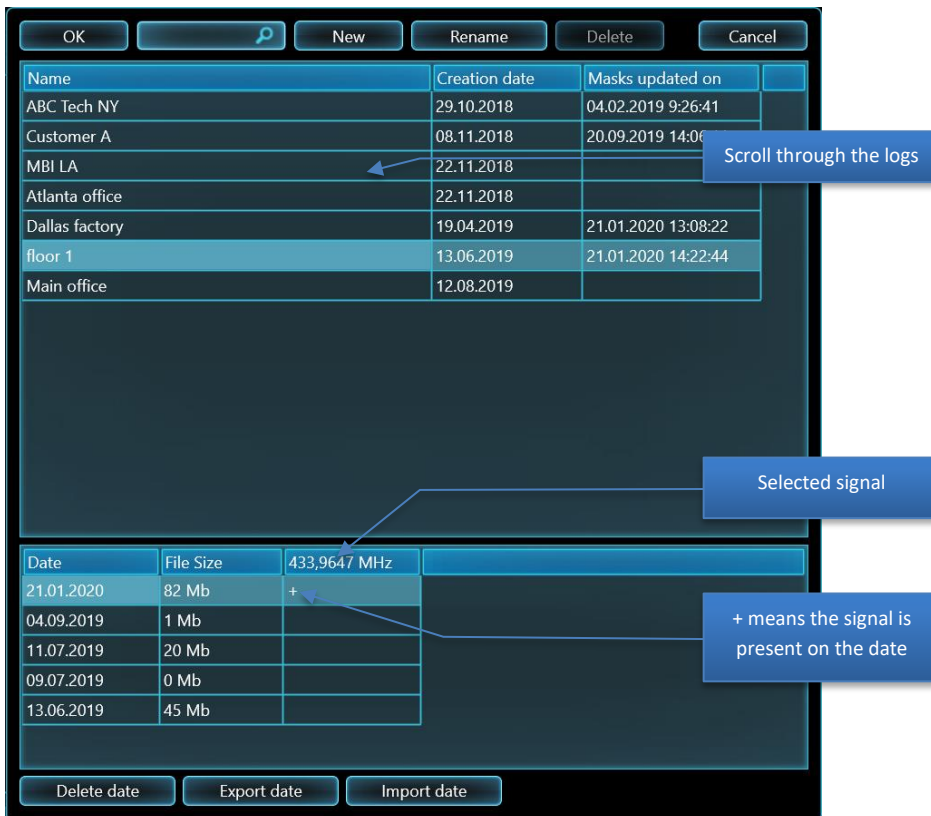

Scroll through the logs and watch for the "+" near the dates; this means the presence of a signal within that date. The old date can be immediately opened and the signal can be reviewed when the software is in the "Stop / View Log" or "Signal Analyzer" mode. Do not forget to return to the current log and date after opening an old date.

Use the "**Selected signal - Reset danger**" command when it is necessary to clear the signal's peak danger and remove it from the list of dangerous signals. As standard the peak danger keeps the highest value measured during all previous sessions throughout the day. The operator may want the peak danger to be cleaned, for example, after the band's threshold is increased or the known signal's mask is re-updated. When the filter is set to "Dangerous" and the signal's danger is reset it will disappear from the Signals table. Please only perform this operation with full confidence in the safety of the signal.

"Selected signal – Delete" – erases the current signal.

"All signals – Export signals..." - exports the Signals table to the .txt file.

"All signals – Show values" - turns on the showing of extra columns in the Signals table with the text values of dbm and danger level.

"All signals - Reset danger" - clears all signals' peak danger. When the filter is set to "Dangerous" the Signals table will become empty. Please only perform this operation with full confidence in the safety of all signals.

"All signals – Delete All" erases all the signals from the Signals table.

The "**Generate Report**" feature allows the operator to export the results of detection into a PDF file. Please read section "Reporting".

The "**field's headers**" are used for sorting the signals. Subsequent clicks on a field's header sorts the signals in an ascending and descending order. The subsequent clicks on the dBm and Danger firstly sort by the current level (darker color) and then by the peak level (lighter color).

The common signals and bands are sorted simultaneously not depending on which header was clicked.

The **toolbar for the common signals** is shown and hidden when the section's header is clicked. It contains the following controls:

- Labels with the central frequency and name
- **"Add to known"** – adds the current common signal to the Known Signals table. Please read section "Adding signals to the Known Signals table"
- **"Update mask"** – re-updates the mask of the selected known signal. Please read "Updating mask of a known signal"

The **toolbar for the bands** is shown and hidden when the section's header is clicked. It contains the following controls:

- The **Name** of the selected band
- The **current dBm level** of the selected band
- The **threshold** for the selected band. Please read the "Adjustment of the bands' thresholds".

Locator

The Locator significantly simplifies the process of tracking the results of detection and the physical locating of transmitters.

While the Signals table lists all registered signals, including the non-active ones, the Locator displays the currently active dangerous signals only. The position of a signal on the Locator's circle is selected depending on the level of danger. Strong and close signals, with a danger level near 100%, are situated in the center, while weaker and further signals with a low level of danger are positioned near the outer edge.

Thanks to the visual ranking of the signals the operator can easily distinguish between close and far sources. As the Delta X system or its antenna is being moved the approached RF source is displayed closer to the Locator's center so that the operator can easily pinpoint it.

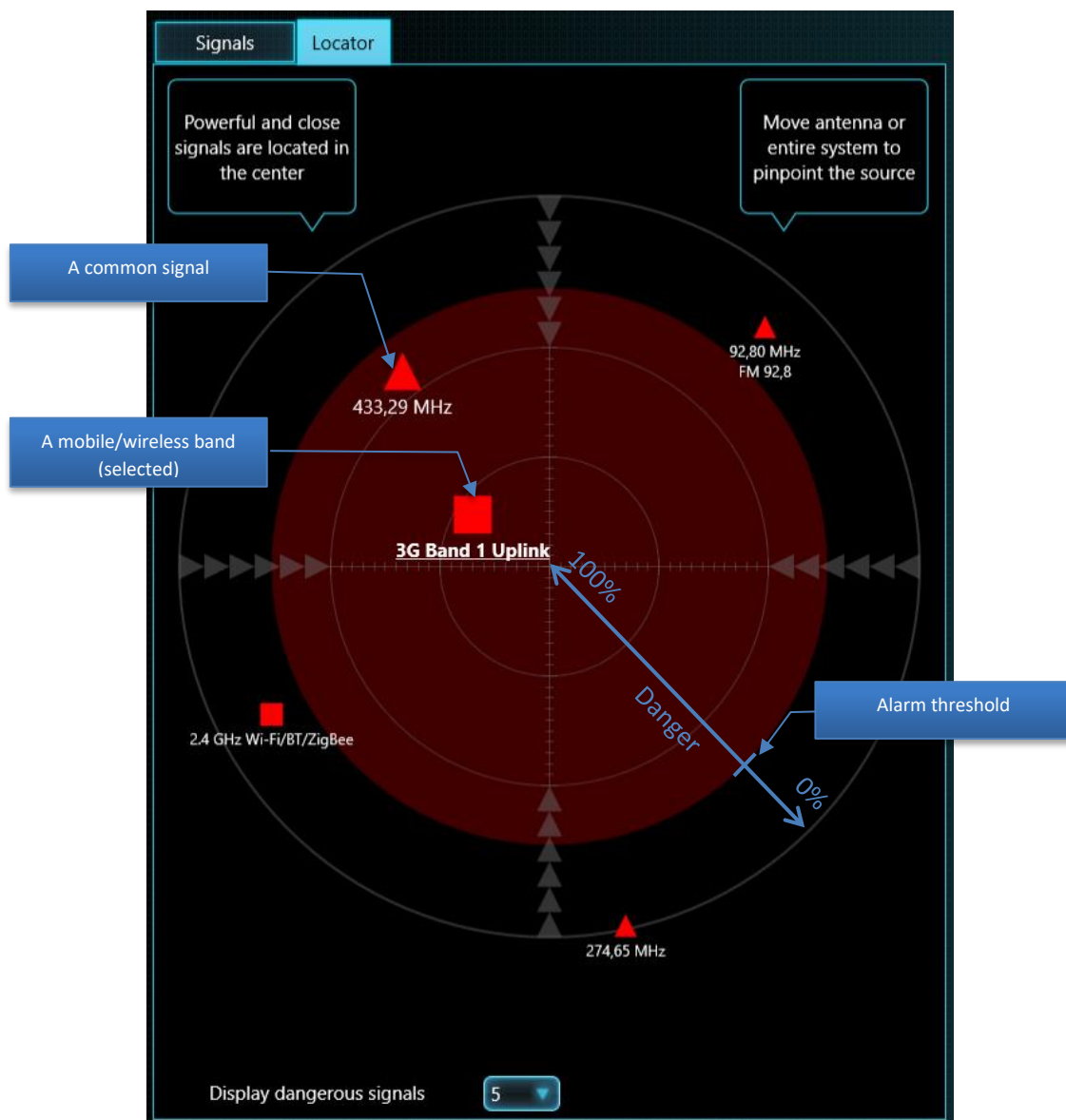

A mobile or wireless band is displayed by a red square, while a common signal – by a red triangle.

The signals which exceed the alarm threshold and get into the red zone are drawn by a bigger shape (please read about the alarm threshold in the next section - Detector). The signals below the alarm threshold are drawn smaller.

"**Display dangerous signals**" allows the operator to set the desired quantity of displayed signals.

Click onto the signal to select it in the Signals table and show it on the spectrum graphs. The currently selected signal is drawn underlined in the Locator. Please bear in mind the "Hold Max Danger" function, which automatically re-selects the most dangerous signal when active.

The Locator function can be engaged in any working mode. In the RF Sweep, Guard 24/7 or Car Tracker Detector mode it will display a number of dangerous signals simultaneously, while in the Signal Analyzer mode it only shows the currently selected signal. This function can also be used in the Stop / View Log mode to see how strong the signals were during detection.

Using the Locator in the Signal Analyzer mode for physical locating of the transmitter is strongly recommended. The physical locating is performed by scanning the area with the antenna and finding the place with the strongest danger level, i.e. when the signal is centered in the Locator.

Detector

The Detector is created for informing the operator about the detected danger events and locating the transmitter. It shows the current level of danger on the bargraph and notifies the operator with the audio alarm. In addition the Detector displays the history of the danger events on the Alarms graph.

The physical locating of the transmitter is performed by finding the place with the highest danger level (both the Locator and Detector can be used at the same time). The audio alarm function produces proportional sound when activated.

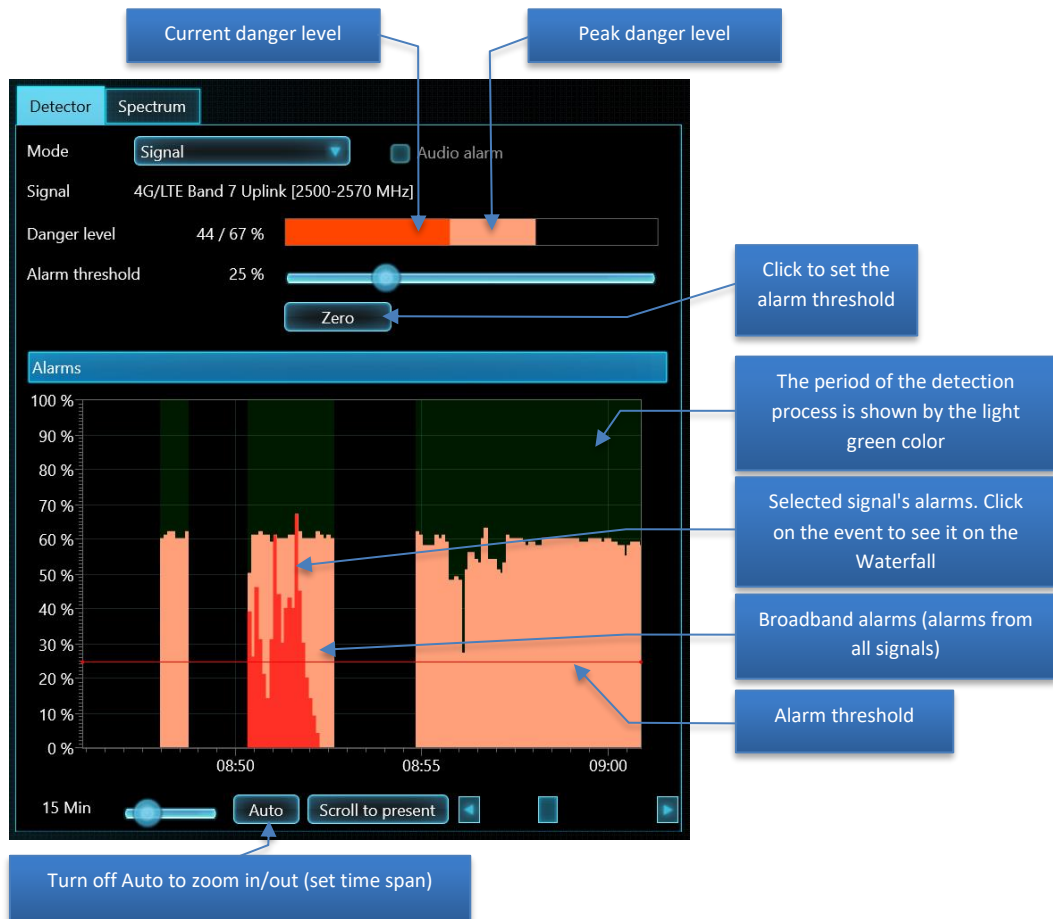

The Detector can work in 3 modes: Wide-Range, Signal and Selected range.

In the "**Wide-Range**" mode the Detector monitors all signals simultaneously. The operator can keep an eye on the general RF situation existing in the area by watching the bargraph and listening to the audio alarm. When a new dangerous signal appears, the Detector will warn immediately. Use the Locator to observe the danger level of separate signals.

In the "**Signal**" mode the Detector displays the danger level of a particular signal which is currently selected in the Signals table (whether common signal or band). This mode can be used during the locating procedure, or for studying the history of a separate signal.

In the "**Selected range**" mode the Detector displays the danger level of a frequency range selected in the Spectrogram. This mode can be used for physical locating of:

- hopping signals thanks to the ability to monitor a number of channels at the same time;
- narrow signals existing within a mobile/wireless band, for example, Bluetooth or Zigbee

When the "**Audio alarm**" is on and a danger event is detected, the Detector will produce the warning clicking sound. The intensity of clicks is proportionate to the level of danger. This function is used for the physical locating of the transmitter.

The "**Alarm threshold**" allows the operator to adjust the level at which the Audio alarm starts producing sound. The alarm threshold helps to avoid false alarms occurring from the insignificant changes of safe signals' spectrums and is convenient during the physical locating (localizing) procedure. The default value is set to 25% in all the detection modes, except the Car Tracker Detector, where it is 10%.

The increase of the alarm threshold is helpful during physical locating since it decreases the area around the transmitter where the alarm audio appears. Increase the threshold step-by-step in order to outline the location of the transmitter.

It is possible to change the alarm threshold by clicking the vertical "%" scale of the Alarms graph.

The "**Zero**" button allows the operator to quickly set the audio threshold equal to the current level of danger and as such reject all weaker values. It can be also useful during the physical locating procedure.

The "**Alarms**" graph displays the history of danger events. Broadband alarms, i.e. maximum possible danger at each moment, are drawn in light red. The level of danger of the selected signal is shown in darker red and is rendered in the Signal mode only.

- The **time span** adjustment allows the operator to select the displayed time span, when the Auto is off. The time span can also be selected with the help of the mouse wheel or by the standard gestures "Pinch" and "Spread" on the touchpad or touchscreen
- The "**Auto**" button automatically adjusts the time span so that all the logged danger events are displayed
- The "**Scroll to Present**" button scrolls to present time
- The **scrollbar** allows the operator to scroll in time in order to see the events at any desired moment (when the Auto is off).

Clicking on the Alarms graph works differently depending on the working mode of the Delta X:

- In the Stop/View Log mode a click scrolls the Waterfall to the corresponding time, loads and displays the corresponding trace on the Spectrogram and shows the dBm and Danger levels in the Signals table which existed at the moment of clicking. The Locator will show the dangerous signals which existed at the moment of clicking.
- In all other modes a click just scrolls the Waterfall to the corresponding time

Spectrum

The Spectrum page displays the graphs responsible for visual representation of spectrum:

- The **Spectrogram** in the upper part renders the frequency on the horizontal axis and the dBm level on the vertical axis.
- The **Waterfall** in the bottom part shows how the spectrum is changing in time. Its horizontal axis is the frequency, the vertical is the time and the color of pixel reflects the dBm level.



Spectrogram

The **Spectrogram** can display the following data:

- Persistence - a way of rendering the traces with color depending on the continuity (persistency) of the signal. Please see the description below.
- Live – the current trace, obtained during the last update. Shown by green color.
- Max – the maximums accumulated during the current operation. Shown by orange color
- Threshold – the reference trace used by the detection algorithm for the selection of signals from the trace and estimating their level of danger. Is shown by red color

A **click** on the Spectrogram when in the Signal Analyzer mode allows the operator to tune in the desired frequency. The **marker** (vertical line) will show the selected frequency. When the graph is scrolled to another range and the marker is not visible, the "**Scroll to marker**" button goes back to it.

The Spectrogram allows the user to make a **selection** with the help of the left mouse button. It is possible to zoom into the selection with the help of the "**Zoom in selection**" button. Thus, a desired frequency range can be quickly viewed. Please note, that when the signal is double clicked in the Signals table the selection of its bandwidth in the Spectrogram is made automatically.

The **displayed frequency span** can be selected with the help of the corresponding control. It is possible to select the convenient value of between 0.5 MHz and 6000MHz. The span of the spectrogram and waterfall is selected simultaneously. The span can also be selected with the help of the mouse wheel or by the standard gestures "Pinch" and "Spread" on the touchpad or touchscreen.

The **frequency scroll** allows the selection of the desired frequency range. The Drag gesture over the Spectrogram can be used on touchscreen computers.

In some cases the displayed span and scroll will be selected automatically:

- When a signal is double clicked in the Signals table
- When the Hold Max Danger function is activated and a more dangerous signal is detected

The **band labels** display the edges of the mobile and wireless bands which exist in the Bands table and get into the displayed frequency range.

The **toolbar for the Spectrogram** can be shown and hidden by a click on the Spectrogram's header. It contains the following controls:

- Setting of the **Persistence, Live, Max and Threshold**
- The "**Max clear**" button is available in the manual modes
- The **Dynamic range** selector. The higher selection -90...-10 dBm allows the user to observe strong signals better, the moderate -90...-30 dBm suitable for most tasks, while the lowest -90...-50 dBm is suitable for viewing the weakest signals.
- The **Color scale** displays how the color in the Waterfall depends on the dBm level and the color in the Persistence depends on the activity of signal. The Color scale changes as the Point of Yellow is adjusted.
- The **Point of Yellow** sets the dBm level to be displayed by yellow in the Waterfall and the level of activity to be displayed by yellow in the Persistence

Persistence

The Persistence is the way of rendering the spectrum with color depending on the activity of the signal, i.e. how frequently it exists. As such the operator can distinguish between permanent and intermittent signals. The rare intermittent signals are drawn in blue or green color, whereas more permanent signals are shown in yellow or red.

A great advantage of the Persistence is that it allows the operator to recognize constant signals hidden under intermittent signals.

Below is an example of finding a Bluetooth bugging device hidden under the Wi-Fi signal:

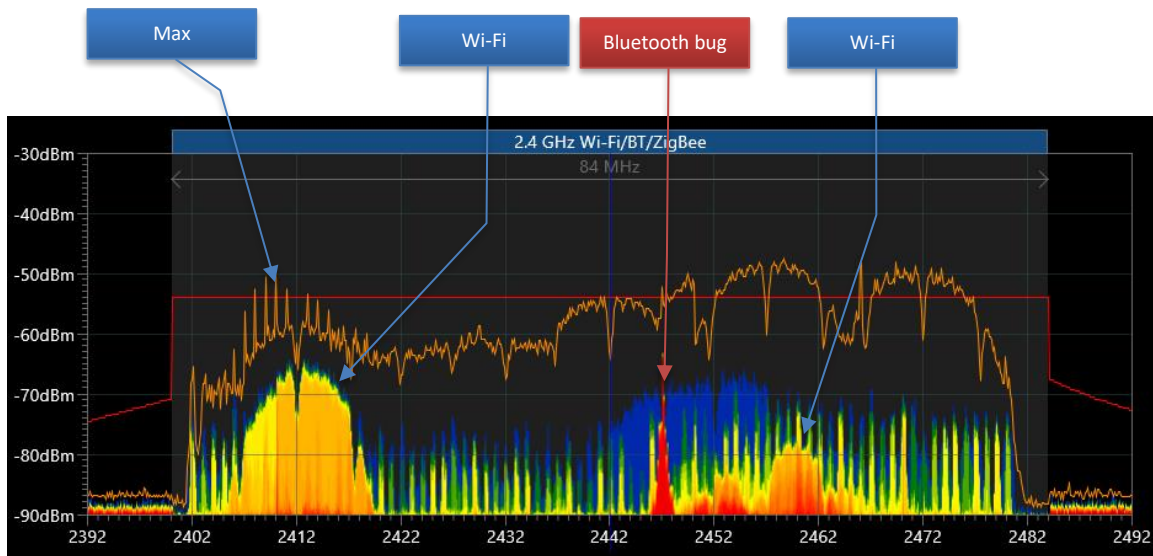

The Max trace contains the maximums accumulated from the intermittent signals during a long period of time and therefore cannot be used for visual recognition of a hidden signal with a lower level. At the same time the Persistence clearly shows in red the 2447 MHz signal with more frequent existence than a blue and yellow Wi-Fi signal "behind" it.

The Persistence uses multiple spectrum traces taken from the Waterfall; therefore the Waterfall's view and settings influence the Persistence.

The Point of Yellow controls the colors in the Persistence.

As a standard, the green "Live" trace is displayed filled. When the Persistence is activated, the filling of the Live goes off and the trace is displayed just by a stroke.

Waterfall

The **Waterfall** displays the multiple traces obtained during a specified span of time and is extremely valuable for the detection of intermittent signals.

During detection the Waterfall displays the information accumulated in the log and scrolls as a new measurement is performed. In the Stop / View Log mode the waterfall displays the information stored in the log. In the manual modes (Wide-Range Analyzer and Signal Analyzer) the Waterfall temporarily accumulates data for the displayed frequency span.

The "**density**" regulates the time span displayed by the Waterfall. The density may vary between "one trace per 10 pixel lines" up to "10 traces per one pixel line".

When the data is loaded from the log in the detection modes or in the Stop / View Log mode a higher density setting may cause significant disk reading and a large processing of data. Therefore fetching may take longer, particularly when a wide displayed span is selected. Try to avoid maximum density with the simultaneous wide span to achieve optimal performance. After using a high density return a low value.

When in the Stop / View Log mode a **click on the waterfall** allows the user to upload and view the corresponding trace in the Live. The Signal table will display the dBm and Danger values which existed at the clicked moment.

The **time scroll** allows the operator to select the desired time shown by the waterfall. It is also possible to select the time by clicking on the Alarms graph in the Detector. Please note that when the Waterfall is scrolled to an older span of time, it does not update with a new trace received from the spectrum analyzer. Scroll to the current time in order to restore the updating.

The **color scale** near the Spectrogram allows the operator to see how the color of the Waterfall's pixels depends on the dBm level. The **point of yellow** can be shifted up in order to hide weaker signals or background noise in the Waterfall. A further increase of the yellow point will hide signals of an average level. Shifting the yellow point down will show weaker signals.

Modes of operation

Update Masks

It would be too difficult to find a surveillance transmitter among the huge number of broadcasting and communication signals which exist in any modern environment if those signals were not filtered out. The great advantage of the Delta X is its ability to mask any safe background signals.

How the masking works

A signal becomes dangerous and produces an alarm when it exceeds the threshold. The threshold for the masked signal lays higher than the signal and therefore is not exceeded. As a result, the masked signals do not produce danger events.

Below is the example of the FM band with non-masked and masked signals:

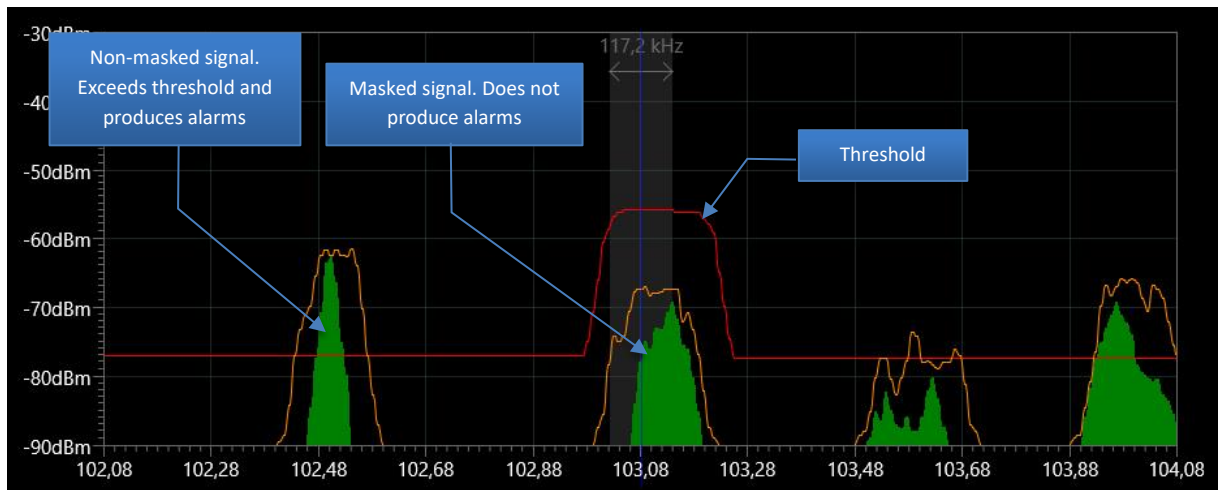

In the Update Masks mode the Delta X can be adapted to the current radio-frequency environment before any detection. This procedure significantly reduces false alarms and increases the general detection sensitivity since it stores spectrums of all safe signals existing in the area and uses them for generating the threshold further during a detection. Both the known and unknown signals are masked.

Perform the Update Masks procedure each time you are going to use the Delta X in a new location.

Antenna connection: connect the omnidirectional wideband antenna ODA-4 to the INPUT socket.

It is recommended to perform the procedure at a minimum distance of 50-100 meters to the target area. This will prevent the system from masking a real danger (bugging signal). Longer distances are also possible. When the building's shape does not meet the distance requirements a distance of 15-20 meters can be selected, however, this closer proximity might decrease the detection distance.

Suggestions for selecting the location of masks updating:

- Target zone on a lower floor: from the vehicle before entering the building
- Target zone on a higher floor: in a remote room or a distant corridor on the same floor, or a few floors higher

- Combining a number of measurements in different points decreases the rate of false alarms during the subsequent sweeping; therefore you can repeat the procedure (example: vehicle + remote room). Please read about the "Add another point" button below.

Start the Delta X system in a remote place and run the 'Update Masks' mode. To provide for proper reception of external broadcasting signals place the system, or its antenna, near a window if possible. Move the antenna in different directions and angles in order to accumulate the highest levels.

The computer running the Delta X, like other sophisticated electronic devices, may produce Radiated Spurious Emissions (RSE). These emissions can be picked up by the system and create false alarms during a search. To mask the RSEs; mount the antenna on the upper part of the case or hold it 10-30 cm away from the computer for 1-2 minutes when the Update Masks procedure is being performed.

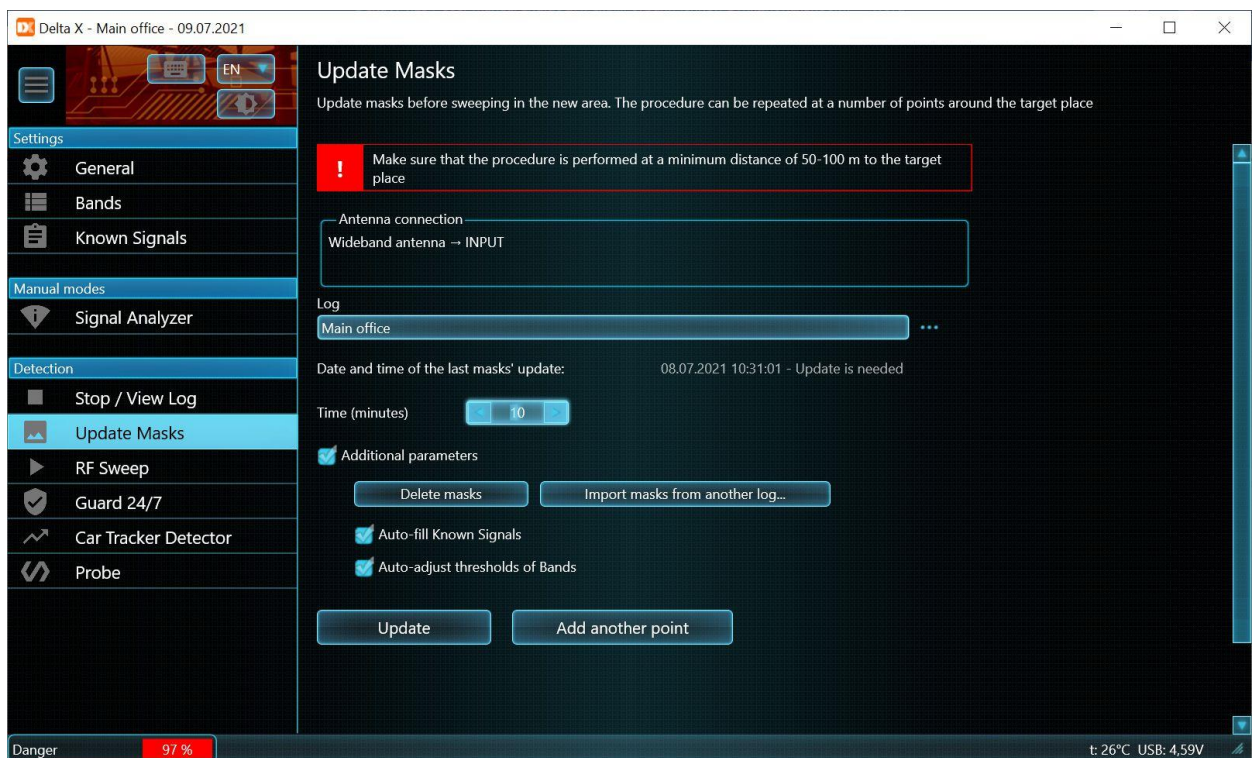

Select the **time** of update in minutes. With a longer time the system will have more chances to capture non-constant signals like wireless remote controls, VHF/UHF transceivers, etc. and as such to mask them. The default value is 5 minutes.

The **additional parameters** contain the following controls:

When the **"Auto-fill known signals"** is checked the system will automatically recognize the local TV and FM signals and store them in the "Known Signals" table in accordance with the local frequency assignment. It is recommended to use this option after coming to a new area or city and clearing the Known Signals table. An alternative method is to use the "Add to Known" button when scrolling through the Signals table. Please read section "Adding signals to the Known Signals table".

The **"Auto-adjust thresholds of Bands"** automatically sets the optimal thresholds for mobile and wireless bands in accordance with the local RF environment. The system chooses a higher sensitivity for the uplink and duplex bands and a lower sensitivity for downlinks. Later during the detection you can change the

threshold manually using the toolbar for bands. Please read section "Adjustment of the bands' thresholds".

Press **"Update"** to start the process. The progress bar will show the status.

Additional mask updates may reduce false alarms even more. Use **"Add another point"** to perform more measurements. Please note that the Update button clears the old masks, while the Add another point adds new data to the existing ones.

Below is the example of placement for the Update Mask in a modern city. The red spot is the target zone. The circle of 50-100 m radius is the non-recommended zone. The suggested places for updating masks are drawn by the green spots.

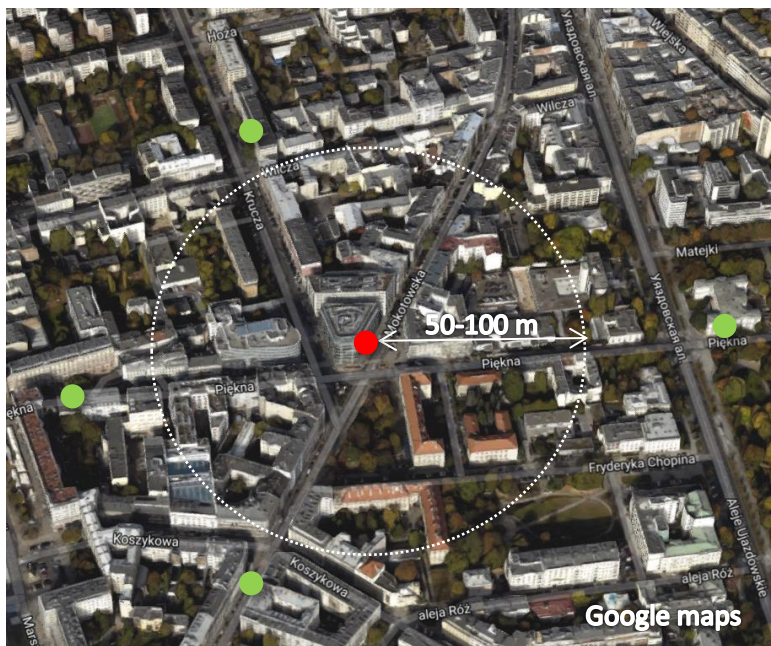

- Target zone
- Places suitable for the Update Masks procedure

The results of the Update Mask are saved automatically.

RF Sweep

This is the main detection mode, in which the Delta X detects signals, evaluates their danger level and warns the operator about any high danger. The signals, alarm events and spectrum traces are saved in the log.

The RF Sweep mode provides extremely high sensitivity thanks to the ability to omit the safe broadcasting and communication signals existing in the area and detect all other signals.

This mode is suitable for the following tasks:

- Checking premises for the presence of RF bugging (sweeping procedure)
- Checking vehicles for the presence of GPS trackers and RF bugs
- Securing conference rooms during negotiations, etc.

Preparations

The following preparations should be made before starting the RF Sweep:

- The country of use must be specified, the Bands table must be set up
- The Update Masks procedure performed
- To simplify the subsequent identification of signals, the 'Known Signals' table can be filled in advance, during the 'Update Masks', or manually (not obligatory)
- All nearby mobile phones must be switched off or put in "flight (plane)" mode. All known wireless devices like access points, video cameras, baby monitors, printers etc. must be switched off. Wireless phones must be switched off.
- If the option "Scan 802.11 wireless access points" is inactive, the computer running the Delta X should be in the "flight (plane)" mode
- Sound in the checked room should be created to activate any potential bugging devices and force them to increase their transmission power. The laptop with the Delta X can produce music, or a language tuition course for example to achieve this.

Initial parameters

After selecting the RF Sweep mode the operator is asked to set the initial parameters.

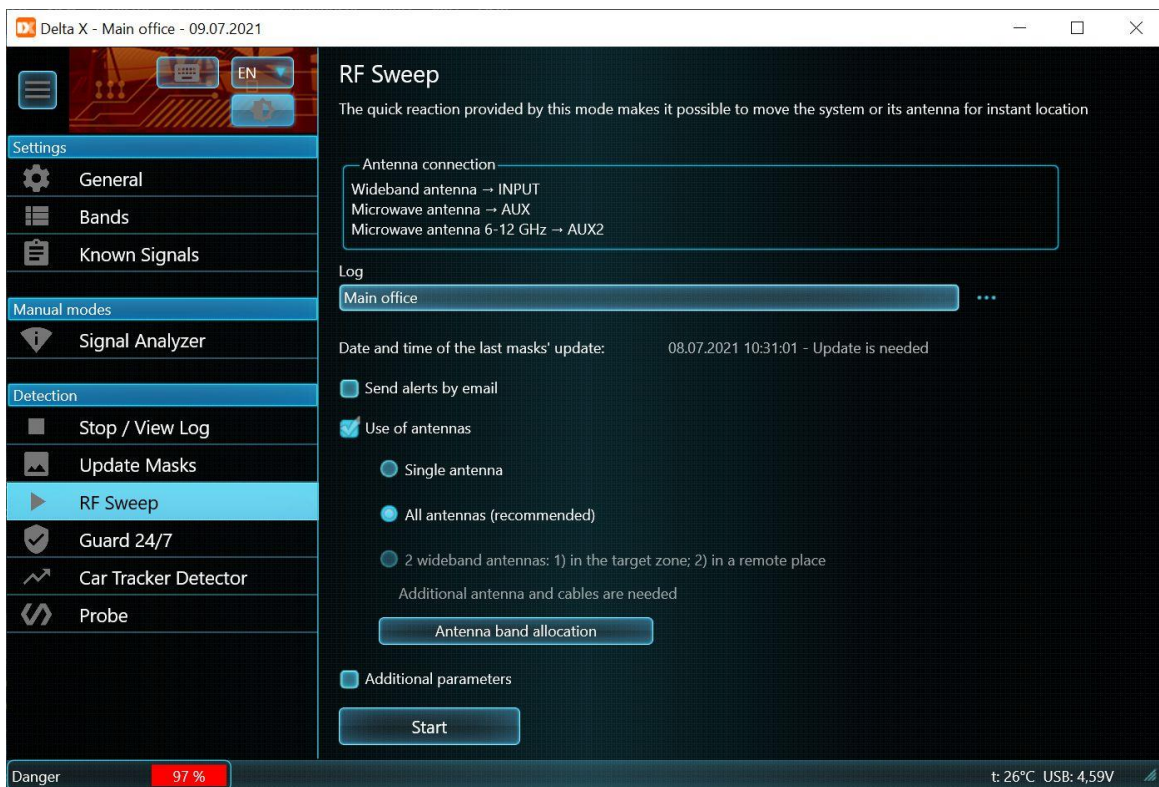

The "**Antenna connection**" box displays the recommended antenna connection scheme according to the selection in the "Use of antennas".

The "**Date and time of the last masks' update**" warns if the masks are out-of-date or absent.

"**Log**" selects to what log (database) the data will be written. Press the selection button if necessary. The log selection window will pop-up. Please see the "Stop / View Log" section for details.

Use of "**Send alerts by email**" is described in the "Email notifications" section.

The unchecked by default **"Use of antennas"** allows the operator to select which antennas are used during a sweep:

- **"Single antenna"**. This mode is used in the older Delta X models with no support of multi-antenna switching.
- **"All antennas (recommended)"**. Use of multiple antennas allows the system to reach the highest sensitivity and detection distance within the entire frequency range. By default, the ODA-4 wideband antenna is engaged for the range of 9 kHz – 3 GHz. The MWA-6 microwave antenna is applied for the next 3 – 6 GHz segment. The Delta X G2/12 is supplied with a third antenna LPDA-12 which is responsible for 6-12GHz range.
- **"Two wideband antennas"**. This special mode is available in the "Guard 24/7" mode only. Please see its description in the section "Usage of 2 wideband antennas".

It is possible to change the antenna band allocation for the ODA-4 and MWA-6 in the popup menu displayed by the button **"Antenna band allocation"**:

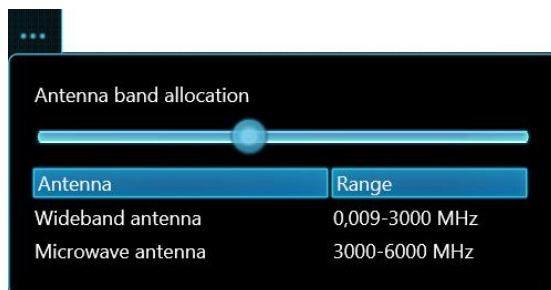

Move the slider to change the antenna switch frequency. Decreasing the frequency allocates a wider range to the MWA-6 microwave antenna. In accordance with its efficient range the lowest allowed value is 800 MHz.

It is strongly recommended to consider the directional nature of the microwave antennas during sweeping. The detection distance of a signal will change depending on being directed or not. To avoid false alarms and an insufficient detecting distance it is recommended to change the direction of the system during the detection process. Slight periodical rotation will help the user to discover signals in all directions around the antenna.

The unchecked by default **additional parameters** contain some extra controls:

"Frequency range" helps to specify the swept frequency range. It is recommended to use the default values, although a narrower span might be specified when it is necessary to watch and log some suspicious signals in a specific range. The default values are set each time the Delta X software is started.

The **"Entire"** button sets the full available range. The **"Optimal"** button limits the range to 6 GHz. Selection of the partial range helps to speed up the detection process.

The **"Set state of controls"** helps to initialize some functions when the detection is started:

- Turn on Audio Alarm
- Set Filter to "Dangerous"
- Turn on Hold Max Danger

To start detecting press the **Start** button.

Within a few seconds, after initialization of the USB connection, detection will start.

Detection process



In the RF Sweep mode the software automatically recognizes the signals in the spectrum traces, adds them to the Signals table and updates the dBm and danger levels. The trace's fetch time depends on the number of allocated mobile and wireless bands and which version of the system is being used:

Delta X 2000/6 Real-Time	Delta X G2/6	Delta X G2/12
2-3 seconds	2-3 seconds	3-4 seconds

The Signals are divided into Common signals and Bands. The Bands contain the activities registered in the mobile and wireless ranges while the rest of the signals are placed into the Common signals category.

The excess of the threshold may mean that the signal has a local origin. The aim of the Delta X is to discover all local transmitters; therefore, such signals are assigned a higher danger level. The level is calculated on the above-threshold basis and takes into consideration the dBm level and the bandwidth of the signal.

The Danger level is drawn by red and reflects the current level of danger. The Peak Danger is drawn by light red. It keeps the maximum danger level and allows the operator to observe any non-constant signals.

The "Dangerous" filtering can be applied to select the signals with a Peak Danger above 0%

The Detector and its Audio alarm function warn the operator about the detected danger visually and with sound. The intensity of the sound changes depending on the signal's power, which makes it possible to locate the transmitter instantly. The Detector can work in the Wide-range mode, informing the operator about all the signals simultaneously, in the Signal mode, where the particular signal is displayed and in the Selected Range mode, showing the alarms which appear in that specific range.

The Locator helps the operator to observe the results of detection by displaying dangerous signals and changing their position on the circle depending on the level of danger which reflects proximity and power. The below example shows 5 detected dangerous signals: 3G (the closest to the center, is a 3G bug with a SIM card), 2.4 GHz Wi-Fi camera, 5864,30 MHz (wireless camera), 275,02 MHz (audio bug), and 5864,44 MHz (second signal from the wireless camera)

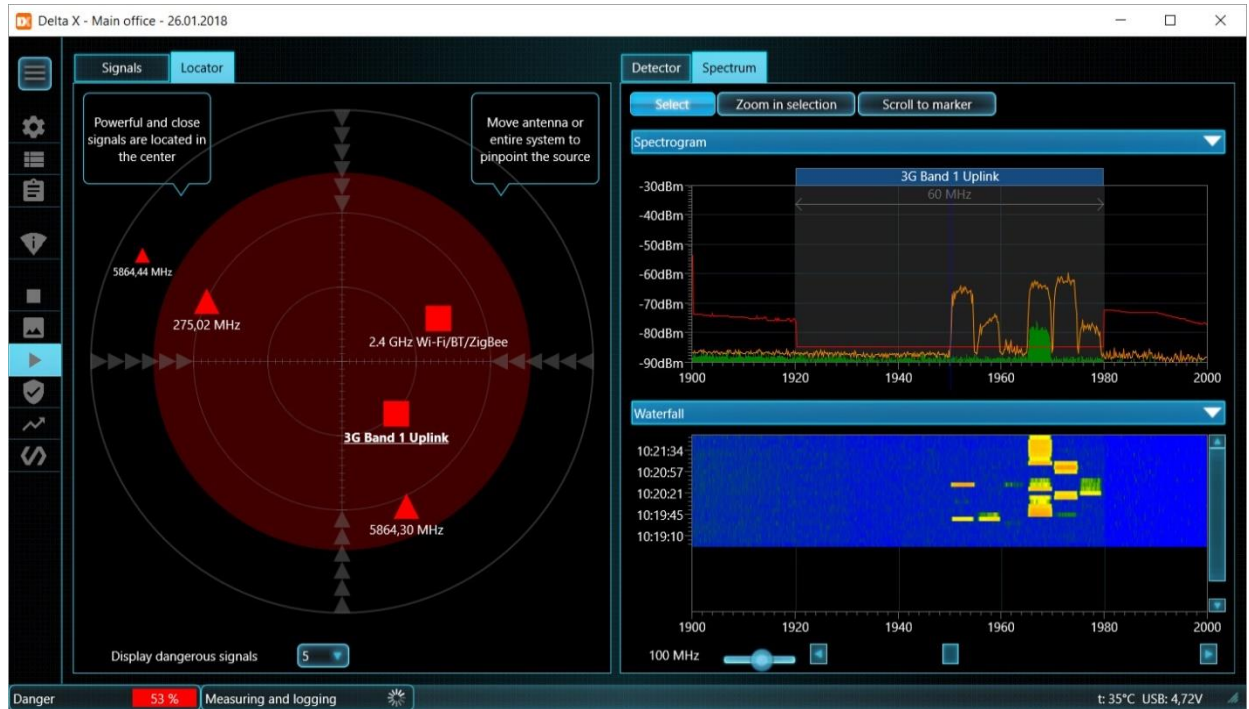

The default value of the Alarm threshold is 25% in the RF Sweep mode. Such a value allows the operator to pass most of the false alarms while keeping the ability to capture any real danger. The red circle on the above example displays the selected threshold.

The left bottom corner of the Delta X software displays the danger status. The color of the rectangle changes depending on the danger level and is green for low values, yellow for a moderate danger level and becomes red as the level becomes higher.

The "Hold max danger" function can be activated when entering the RF Sweep mode or later. This function places the dangerous signals on the top of the Signal table and tunes in the signal with the highest danger level.

When it is necessary to review other signals or change the displayed frequency span or scroll in the spectrum graphs, the Hold Max Danger must be turned off.

Updating mask of a known signal

Some signals may become dangerous and produce alarms during a detection despite the fact they were previously masked. This can happen in areas with a good reception of broadcasting - on upper floors, in

buildings facing TV towers, etc. If a signal is stronger in the room being checked it might become dangerous.

If the operator is convinced of the safety of the known signal, the signal's mask can be updated with the help of the Update Mask button on the common signal's toolbar.

A safe signal has these characteristics:

- The form of the threshold tells that the signal existed during the Update Masks procedure
- The signal's spectrum has a typical shape and level comparable with other similar signals
- The signal's strength (dBm and danger) tend to grow near the windows which means it has an external origin
- The signal has similar spectrum and strength in a number of rooms including the remote ones
- There is no sharp increase of strength in any certain place, except the windows

To study the signal, the Signal Analyzer mode can be started temporarily and the antenna, or the entire system, moved in the premises.

If the signal is unknown, its mask cannot be updated during the detection. If the signal is identified and has all signs of safety it can be added to the Known Signals table first. Then its mask can be updated. Please read "Adding signals to the Known Signals table".

The new threshold reflecting the updated mask will be displayed after the new spectrum trace is fetched.

After the signal's mask is updated its current danger becomes zero. It is possible to reset the peak danger with the help of the "Reset danger" command from the "Popup menu - Selected signal". As a result the signal will be removed from the list of dangerous signals.

Below is an example of updating the mask for the known signal 751.25 MHz:

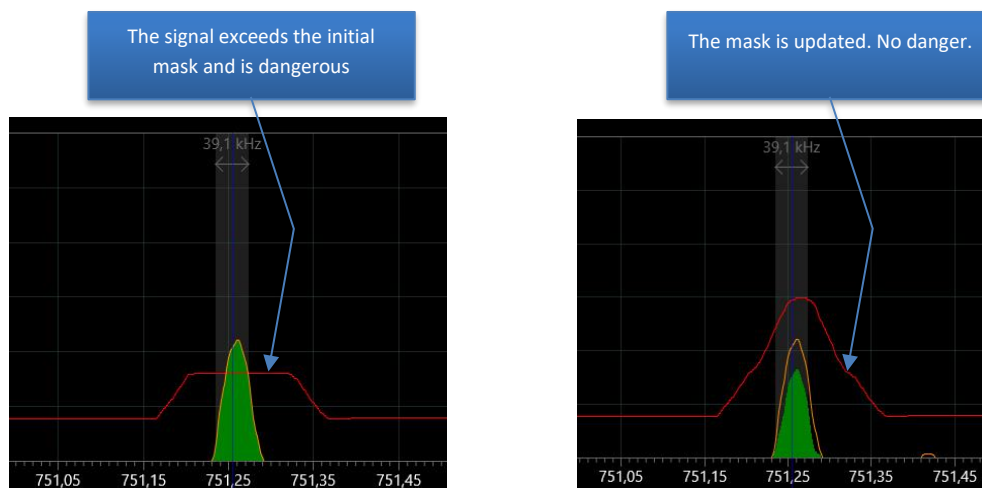

The re-updating of the mask can be done in the following modes: Signal Analyzer, RF Sweep and Guard 24/7.

Continue with other signals producing alarms. If many known unknown signals are showing danger, it is recommended to repeat the Update Masks procedure in a remote place.

Adjustment of the bands' thresholds

Sometimes it is necessary to change the sensitivity of the mobile and wireless bands in the target zone:

- To change the detection distance
- To re-adjust the sensitivity in a new place of detection
- When the nearby mobile base stations (downlinks) produce alarms
- When any inaccessible mobile and wireless devices in a neighboring office or flat create interference

Open the Band's toolbar by clicking on the "Bands" header, select the desired band and adjust the threshold using the track bar:



Make sure the "Hold max danger" function is inactive.

The downlink bands should not normally produce alarms and therefore the threshold for them should be above the dBm level. Do not set the value too high to avoid losing sensitivity.

The uplink and "shared" bands (without the "uplink" or "downlink" label) should be sensitive enough to detect the signals; therefore their threshold level should be lower. Do not set it too low "on the floor" as the band will constantly produce alarm events and create interferences for the detection process.

While the GSM standard needs the threshold to be higher in order to limit the detection of remote devices, the CDMA, 3G, 4G/LTE and 5G should have lower threshold as their dBm level is typically lower:

Standard	Recommended threshold level		
	High sensitivity (longer detection distance)	Low (Shorter distance)	sensitivity detection
GSM	-60 dBm	-40 dBm	
CDMA, 3G, 4G/LTE, 5G	-85 dBm	-75 dBm	
Wi-Fi/Bluetooth/Zigbee	-70 dBm	-40 dBm	
DECT	-70 dBm	-40 dBm	

A decrease of sensitivity may be needed when there are Wi-Fi, cellular or DECT signals coming from the uncontrolled neighboring premises. The higher the threshold is, the lower the sensitivity will be.

After a band's threshold is increased its danger might become zero. It is possible to reset the band's peak danger with the help of the "Reset danger" command from the "Popup menu - Selected signal". As a result the band will be removed from the list of dangerous signals.

Please note that the Update Masks mode adjusts the thresholds automatically if the corresponding option is checked in the parameters. If you wish to keep the manually set thresholds uncheck the option when performing the next Update Masks.

Detection distance

The detection distance depends on the transmitter and is connected with its transmission distance.

A typical bugging device sends signals over 20-200 meters and can be easily detected by the Delta X at a distance of 5-50 meters. At the same time, the 3G, LTE (4G) and 5G standards, due to the specific type of modulation can be detected at a shorter distance of 2-4 meters.

Type of signal	Detection distance
TV, FM broadcasting	5-10 km
VHF/UHF communications	0.2-2 km
VHF/UHF bug	5-50 meters
GSM bug	5-20 meters
CDMA, 3G, LTE (4G), 5G(<6GHz) bug	2-4 meters
DECT	5-10 meters
Wi-Fi	5-10 meters
Bluetooth, ZigBee	2-10 meters
Wireless video camera	5-20 meters

Most bugging devices can be found without the necessity of moving the system or its antenna within the room in order to scan the area. Nevertheless, to obtain the most reliable results and find all types of bugging, including the 3G/LTE and the low-power devices like Bluetooth, the antenna should approach them at least 2 meters. Therefore, moving the system/antenna and scanning the area is recommended.

Scanning the area

The advantages of moving the system or the antenna are:

- Low-power transmitters and some hard-to-detect cellular signals can be detected at a closer distance
- The operator may need to decrease the sensitivity on some bands in order to avoid false alarms from neighboring Wi-Fi and cellular devices. The loss of detection sensitivity can be compensated at a closer distance
- The location of the transmitter can be discovered during the detection

When the **"2000/6 Real-Time"** model is being carried, the antenna(s) must be screwed to the cover of the case. When the Delta X is stationary and the antenna is being carried, the coaxial extension cable and the adapters from the supplied set must be used. The antenna is connected to the INPUT or AUX sockets via the coax cable and adapters. Using the handle/tripod from the supplied set simplifies carrying the

antenna. Scan all areas in the room by moving the system or its antenna smoothly with the speed of 50 cm per second taking into consideration the detection distance of 2 m

The second-generation models **"G2/6"** and **"G2/12"** are fully portable and extension cables are not needed. The entire system together with the laptop or tablet can be moved during sweeping and locating. Scan all areas in the room by moving the system smoothly with the speed of 50 cm per second taking into consideration the detection distance of 2 m. Change the direction periodically so that the microwave antennas probe all directions.

Results of detection

The results can be reviewed in the Detector, its Alarms graph, in the Locator or Signals table during detection. Double-clicking or clicking the signal shows it on the spectrum graphs. When the Detector is in Signal mode, it will show the alarm events of the clicked signal on the Alarms graph.

The RF Sweep mode presumes the detection and locating simultaneously, but due to the processing of the entire frequency range the movement speed is limited. The Signal Analyzer mode can be used temporarily in order to study a suspicious signal and locate it physically. Then the RF Sweep can be continued again.

Press the Stop / View Log after the detection is completed. The information can be reviewed in this mode.

Radiated Spurious Emissions

Many electronic devices like computers, printers, telephones, power supplies, etc. may produce Radiated Spurious Emissions (RSE). The Delta X can detect these weak signals when its antenna is at a close distance. If a weak signal or a few weak signals occur near an electronic device at a distance of 30-50 cm and are absent in all other areas, it may be a sign of RSE. The Signal Analyzer mode can be used for locating.

Training

Before starting the actual detection, a "test" detection with bugging devices of different types can be performed.

Some home appliances and cellular devices work similarly to real bugging devices; therefore they can be used for training in the absence of real bugs.

Bugging device	Replacement
VHF/UHF radio microphone	Body-worn "bodypack" radio microphone used on TV
GSM bug	Mobile phone in GSM mode (with 3G off) in the conversation state. A call from a landline telephone can be made, the phone picked up and left off hook
3G/LTE bug	3G/LTE mobile phone in the conversation or data exchange state. To initiate continuous data exchange Skype or Viber software can be used or a long YouTube video watched
Wi-Fi transmitter (client)	A Wi-Fi connected mobile phone in the state of data exchange (Skype/Viber/YouTube)
Wi-Fi transmitter (server)	Wi-Fi router
Hidden wireless camera	Video baby monitor
DECT radio microphone	DECT phone in the conversation state
Bluetooth bug	Bluetooth headset or wireless mouse in the active state

Cellular devices can decrease the power or intensity of exchange when there is no conversation (no sound). When performing the test training detection, make sure there is a sound near the cellular device.

When conducting tests take into consideration the reaction time in the "RF Sweep" mode. The signal must exist for at least 3-4 seconds to be detected. The reaction is significantly quicker in the "Signal Analyzer" mode which was created for the physical location of the suspicious signal.

When testing the system with a car's remote control take into consideration that the sent signal may last less than the reaction time. The detection of such signals may take longer.

Signal Analyzer

This mode was created for the physical locating and studying of suspicious transmitters. The operator can inspect a signal's level and spectrum, demodulate when possible and add safe signals to the 'Known signals' table. This mode does not capture new signals, but works with the records already stored in the Signals table.

In the upper part of the software there is a toolbar containing some controls specific for this mode:



By selecting the "Input" the operator can switch between the antennas. "Auto" selects the antenna automatically depending on the frequency of the inspected signal and the antenna band allocation.

It might be advisable to use the microwave antenna if you wish to perform a physical locating of a signal with a frequency above 800 MHz. Microwave antennas are directed; therefore, it is easier to find the source - the level grows as you point the transmitter with the antenna.

To change the antenna band allocation press the "..." button. The following popup menu will open:

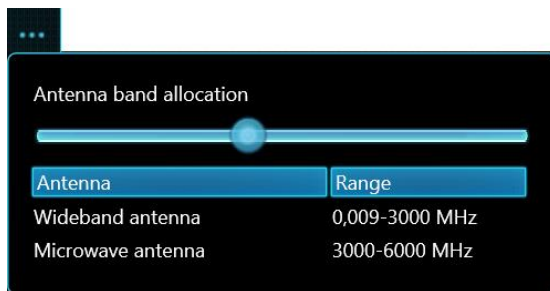

Move the slider to change the frequency on which the wide-band ODA-4 or microwave MWA-6 antenna is selected. Decreasing the frequency allocates a wider range to the MWA-6 microwave antenna. In accordance with its efficient range the lowest allowed value is 800 MHz.

Set the slider to a lower than the signal's frequency value if you wish to activate the MWA-6 microwave antenna. Set the slider to a higher frequency if you want to activate the ODA-4 wideband antenna.

The selected value is saved automatically and will affect the antenna allocation in all detecting modes. The initial value can be restored both in the Signal Analyzer mode or in the initial settings of detecting modes.

The frequency coverage of the third antenna LPDA-12 cannot be changed ("G2/12" only).

For testing needs it is possible to select the input manually: INPUT, AUX (AUX1) or PROBE.

The "**Watch mode**" defines what information is taken from the spectrum analyzer – spectrum or the demodulated sound. With the "**Spectrum**" selected the spectrum graphs will update continually. With the "**Demodulate**" selected the system allows the operator to listen to the signal and select the demodulation mode and bandwidth (BW).

Spectrum

Unlike the RF Sweep and Guard 24/7 where the entire RF spectrum is updated continually, the Signal Analyzer only updates the partial spectrum. Thanks to this a higher update rate is achieved so that the location procedure can be performed faster.

The "**Update Span**" defines the updated frequency range:

- "**Displayed**" (**default**) – the range displayed by the Spectrogram/Waterfall is being updated. As the Spectrogram is scrolled the updated span is changed correspondingly
- "**Selected**" – the spectrum analyzer updates just the selected part of the spectrum in the Spectrogram. The selection is made automatically after double-clicking the signal in the table, or manually with the Spectrogram - Select button in the depressed state. Narrowing the selection might be necessary when monitoring, or physically locating, a separate signal present inside a mobile or wireless band, for example a separate Wi-Fi or Bluetooth channel. The probability of detecting such an intermittent signal increases when a narrower span is monitored. As the selection in the Spectrogram is being changed the updated span adjusts correspondingly
- The "**Real-Time 27 MHz**" option allows for the monitoring of the fixed span of 27 MHz and achieving the highest probability of registering an intermittent (short burst) signal. According to the specification of the used spectrum analyzer the POI value reaches 100% for signals lasting more than 4 microseconds. Select this option when locating a Wi-Fi transmitter or any other short burst signals. This option needs the marker to be set on the frequency of interest.

The "**Number of readings**" defines how many times the trace is fetched from the spectrum analyzer. Thanks to the accumulation of maximums the increased number allows the operator to track any intermittent signals with a short time of existence. For example, a Wi-Fi signal's bursts only last 5-100 microseconds so the increased number will improve the probability of capturing. Increase the number of readings for Wi-Fi, 4G/LTE, 5G and all other non-constantly existing signals in order not to pass the activity during the locating procedure.

Please note that this setting is valid in the Signal Analyzer mode only, while the other modes fetch traces in accordance with their own algorithms.

The "**Frequency**" shows the tuned frequency. The marker on the Spectrogram will be positioned correspondingly. There are 3 ways to change the tuned frequency:

- Double-clicking or clicking the signal in the Signals table
- A click on the Spectrogram
- Editing the value directly using the Frequency control

Demodulation

When the watch mode is set to "**Demodulate**" the Delta X produces demodulated sound on the currently tuned frequency, displayed by the marker in the Spectrogram.

The toolbar in the Demodulate mode:



There are 5 **demodulation modes**: FM (frequency modulation), AM (amplitude modulation), USB (upper sideband modulation), LSB (lower sideband modulation) and CW (continuous wave modulation).

Please note that in our modern environment there are a huge number of digital signals which cannot be listened to with the help of the analogue demodulator. Mobile communications, wireless devices and encrypted VHF/UHF communication cannot be demodulated. Despite this the Delta X warns the operator about the existence of such signals, by detecting their spectrum. The subsequent locating procedure makes it possible to pinpoint the transmitter in the premises not depending on the ability to demodulate.

Analogue bugging transmitters typically use the FM modulation, although some devices sending audio through wires can use the AM or other modes. Radio broadcasting uses both the FM and AM, depending on the band. TV signals can be sent in the FM or AM, depending on the country.

The demodulation **bandwidth (BW)** can be selected in order to achieve the best quality of reception. For example "240 kHz" is suitable for the demodulation of some analogue bugging devices, FM stations and audio channels of TV stations. "15 kHz" is suitable for the reception of some analogue bugging devices and VHF/UHF communications.

It is recommended to apply different demodulations and BWs when inspecting any unknown signals.

To tune in a signal double-click or click it in the Signals table. By default the signal's central frequency is tuned in. Since the carrier of some signals is not positioned in the center (for example TV/video signals), it is recommended to change the tuned frequency within the edges of signal's spectrum in order to study the unknown signal and find possible signs of modulation and audio. Clicking on the Spectrogram sets the marker and correspondingly changes the tuned frequency.

Please note the absence of audio is not a sign of a signal's safety. The more important indication is the absence of a high danger level in different parts of premises. Therefore it is recommended to move the Delta X system or its antenna in order to inspect and locate any suspicious signals.

Physical locating of the transmitter

The procedure should be accomplished in the watch mode set to Spectrum.

Both the Locator and Detector can be used during the locating procedure. It is also possible to monitor the signal's dBm level on the spectrum graph.

The Locator will indicate the danger level by positioning the higher values closer to the center and lower values to the outer edge. The signal's position will move to the center as the Delta X system or its antenna is being moved closer to the transmitter.

The Detector will indicate the danger level on the bargraph. The current value will be shown by red, the peak value - by light red color. The operator will be warned by the proportional sound if the Audio alarm function is activated. The signal's danger will increase as the Delta X or its antenna is closer to the transmitter and will drop at longer distances. The Audio Alarm function will produce a clicking sound with changing intensity, depending on the danger level.

The Spectrum graph will indicate the signal's dBm level. The signal's level will increase as the Delta X system or its antenna is being moved closer to the transmitter (or pointed to the transmitter).

By finding the place with the highest danger or dBm level the operator can locate the transmitter.

The signal's danger level can be between 0 and 100% and is calculated from the above-threshold level and bandwidth. The dBm level can be between -90 and -10 dBm.

While the threshold for common signals is generated automatically, for bands it is set by the operator.

Algorithm of the locating procedure:

1. Start the Signal Analyzer
2. Set watch mode to Spectrum
3. Open the Detector and select its mode as Signal or Selected Range.
4. With the Detector in the Signal mode: double-click or click the desired signal in the Signals table; If you need to inspect a part of the signal (Detector in "Selected range" mode or Update Span set to "Selected"): select the necessary span in the Spectrogram with the help of the mouse' left button (the Select button should be in the pressed state)
5. Turn on the Audio alarm in the Detector
6. Open the Locator
7. Move the Delta X system or its antenna in order to find the place with the strongest level
8. The Spectrum will show the changing dBm level. The Detector and the Locator will show the changing danger level while the Audio alarm will produce sound of corresponding intensity. The level and intensity of the sound will grow as the antenna is moved toward the transmitter. Please note that the danger only appears when the signal exceeds the threshold. If the Detector is in the "Selected range" mode in order to locate the suspicious signal residing inside a mobile or wireless band (for example a Bluetooth, Zigbee or Wi-Fi channel), the threshold for this band should be decreased temporarily so that the signal within the selection exceeds it. In this case the danger bargraph will show a non-zero level.
9. The Alarm threshold allows the operator to mute the audio for weaker levels. By increasing the alarm threshold progressively it is possible to find the area with the strongest signal and, as such, pinpoint the potential transmitter. The "Zero" button quickly sets the alarm threshold to the current level.

Example of locating the 279.54 MHz transmitter:



Some safe signals from broadcasting or communications might produce increased levels or "false alarms". False alarms have the following signs:

- The dBm or danger level changes insignificantly in different parts of checked premises
- The dBm or danger level rises near windows and outside the premises
- There is no sharp increase of level in a certain part of a room
- The same signal exists in other logs obtained in other areas (can be checked with the help of the "Search in other logs" command (popup menu – Selected signal))

At the same time, really dangerous signals have the following signs:

- A sharp increase of level in a certain place
- A high danger level

Please note that the mobile standards (3G/4G/LTE/5G) may use some bands simultaneously. A mobile device may change the band during the communication session. At this moment the signal may disappear from the Signal Analyzer tuned in the initial band. Testing other bands or returning to the detection will be necessary to find the new active band and to continue with the location.

Directed microwave antennas MWA-6 and LPDA-12

The supplied microwave antennas MWA-6 and LPDA-12 (G2/12 only) can help in locating any transmitters working on frequencies above 800 MHz. In addition to the increased sensitivity they can show the direction to the transmitter which simplifies the locating procedure significantly.

- The software will select the antenna automatically depending on the signal's frequency and the antenna band allocation. Use the "..." button near the Input combo box to activate the microwave antenna if necessary. Note the selected antenna on the LED indicator

- Rotate the system or active antenna in different directions to find the strongest danger level or the highest dBm level and proceed in that direction. Carry the Delta X system (G2), or use the supplied 5m extension cable (2000/6 Real-Time).
- After approaching the potential location repeat finding the direction. As such, step-by-step, a precise position of the transmitter can be found.
- Proceed to the physical inspection

The following transmitters can be found with the help of the microwave antennas:

- CDMA, GSM
- 3G
- 4G / LTE / 5G (sub 6GHz)
- Wi-Fi, Wi-Max, DECT, Bluetooth, ZigBee, wireless cameras
- All other signals above 800 MHz

Inspecting wireless bands (Wi-Fi, etc.)

The wireless ISM bands must be checked very carefully during the TSCM sweeping as there are many surveillance devices utilizing these frequencies.

There are 3 most popular ISM bands which are used worldwide:

- 2.4 GHz – used by Wi-Fi, Bluetooth and wireless devices
- 5 GHz - used by Wi-Fi, Bluetooth and wireless devices
- 902-928 MHz – used by wireless devices (not all countries)

If during the search you observe activity on any wireless band (Wi-Fi 2.4, Wi-Fi 5 or 900 MHz) with a danger level more than 0%, it is recommended to study this band separately in the Signal Analyzer mode. The update rate of the spectrum analyzer is higher in this mode; therefore the intermittent transmitter can be located faster.

By moving the Delta X system or its antenna with the extension cable, you can locate the source of a signal as it is described in the section "Physical locating of the transmitter". Use the "Selected range" mode of the Detector and "Selected" of the Update Span when it is necessary to locate a separate signal instead of entire band.

If this is a safe and accessible device, temporarily turn it off. If you find that the signal source is outside the room and is not accessible, you can increase the threshold to stop alarms from it.

The "Scan 802.11 wireless access points by wireless adapter" parameter from the "Settings – General" forces the computer's wireless network card to scan for the available access points periodically and display them on the Spectrogram. Activate this function to simplify identification of wireless signals shown by the Spectrogram. Please note: This function will only work if the computer is not in flight mode.

The SSIDs of any Wi-Fi access points (routers) will be shown on the Spectrogram, each positioned in correspondence with its signal's level and occupied channel.

The vertical position of the SSID (level) will grow as the antenna is brought closer to the access point. If the peak on the Spectrogram coincides with the level of the access point, it may mean you are observing the point's signal. If the SSID's level stays the same and the signal grows, you are probably approaching the active access point's user.

Below is the example of the 2.4 GHz band with 2 active access points and one wireless signal. The spectrogram is in the Persistence mode:

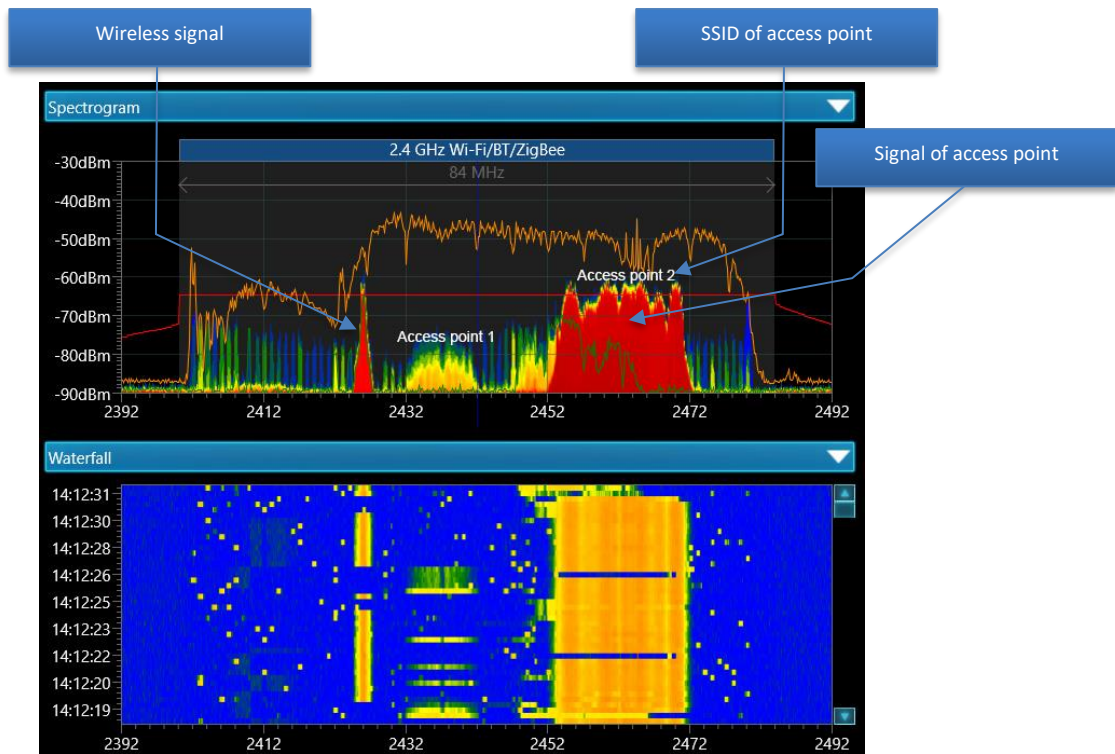

Access points with hidden SSIDs are displayed as MAC addresses.

Rescanning of the access points is carried out every 10 seconds.

Adding signals to the Known Signals table

The Known Signals table can contain the signals of radio and TV broadcasting as well as the other continuously existing signals in your area such as radio communications or wireless signals.

The known signals give certain advantages when the system is constantly used in the same area:

- Quicker identification of signals
- Possibility to re-mask known signals during a detection

The Update Masks mode can recognize most of the selected country's relevant FM and TV signals existing in the area and store them in the Known Signals table.

A more accurate way can be the manual identification of each signal in the Signal Analyzer mode and adding it to the Known Signals table with the help of the "Add to Known" button (Signals – Common Signals – toolbar).

Fill the Known Signals table in the same area (city) where the sweeping procedure is planned, but not exactly in the place of the pending search. In certain cases, if a signal is proven to be safe, for example, if it is a local wireless signal, it can be added to the Know Signals in the place of detection.

- Collect the active signals by running the RF Sweep mode for 5-10 minutes while being in the place of good reception of radio signals – when possible on a higher floor and near a window

- Select signals one by one in the Signals table and inspect them in the Signal Analyzer mode: note the frequency, review the spectrum and listen to the demodulated audio
- If the signal is identified, press the "Add to known" button situated on the toolbar for Common signals
- The "Standard signals" pop up window will show the list of possible variants according to the local frequency assignment (TV and FM signals)
- Select the correct variant taking into consideration the signal's characteristics

In the below example there are 3 options for the signal 91.7627 MHz. The "TV4-Audio" is the most appropriate variant.

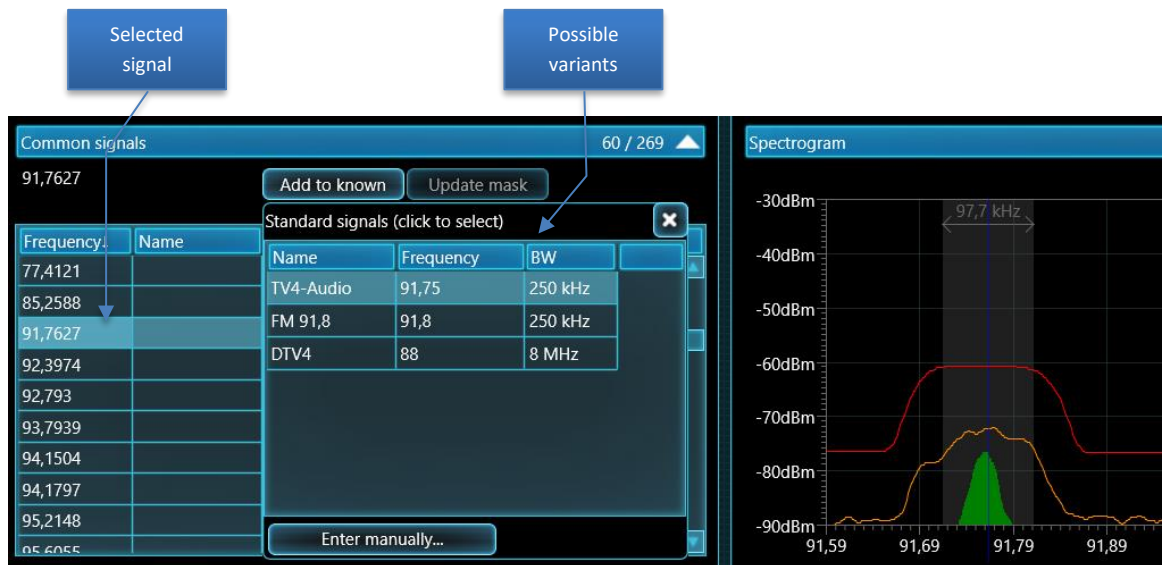

- The name of the signal in the Signals table will be displayed immediately
- Use the "Update Mask" button to mask the newly added known signal or update masks of all signals at once in the "Update Masks" mode after adding all identified signals
- Scroll to the next signal and proceed with its identification and adding to the Known Signals table

The "Standard signals" list contains radio and TV signals. If you have identified another type of transmission, for example, a VHF communications signal, the list will be empty. Use the "Enter manually..." button in this case. The Known Signals table will open with the newly added signal selected. It is necessary to assign a unique name to the newly added signal (obligatory), select the modulation and adjust the bandwidth if necessary. Press the "Apply" and "Back to Signal Analyzer" button when completed.

The frequency assignment is similar for many countries and must be kept in mind during a signal's identification:

Band	Assignment
40-87.5 MHz, 174-230 MHz	VHF TV and DTV
65.8 – 74 MHz	OIRT FM
87.5 – 108 MHz	FM and HD radio
138-174 MHz	VHF communications
380 - 470 MHz	UHF communications
470 - 692 MHz	UHF TV and DTV

Analog TV

An analog TV signal consists of 2 carriers – video and audio, as shown in the illustration of PAL signal's spectrum below:

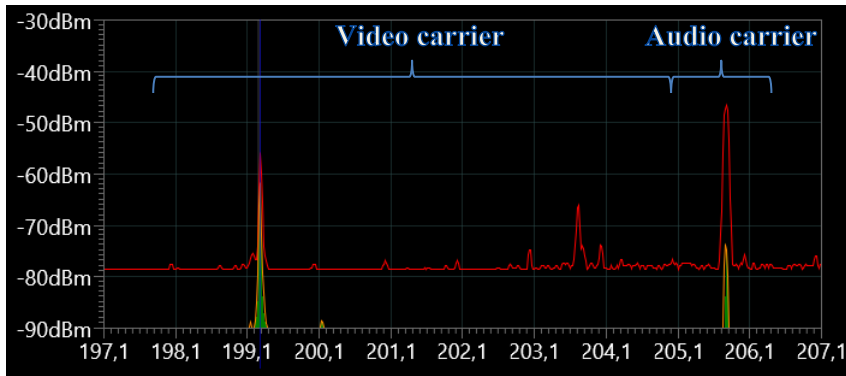
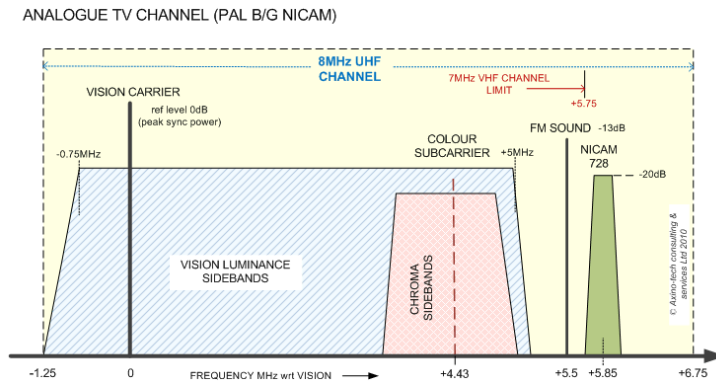

The analogue TV signal (Eastern Europe, channel 9)

The Delta X will capture both video and audio carriers and add them to the Signals table as 2 different signals. Depending on the quality of reception, the bandwidth of a video signal will vary from 50 kHz to 6 MHz, while the audio carrier's bandwidth might be 30-200 kHz.

A video carrier, if demodulated in the AM demodulation mode, will have a characteristic buzz of "vertical scanning". An audio carrier can be listened to in the FM mode.

Please note: when a signal is selected in the Signals table with the help of double-clicking, the Delta X is tuned into its central frequency by default and Spectrogram's span is selected automatically. Since a video carrier is not centered, it is necessary to tune in it manually, by clicking the center of the peak on the Spectrogram, and then listening to the signal. To review the entire TV signal, firstly increase the Spectrogram's displayed span to 10 MHz.

Digital TV

Since Digital Television (DTV) has become more widely used in many countries, some of, or all analog TV signals consisting of a pair "video + audio carrier" are substituted with the modern digital signals occupying the entire bandwidth with one solid carrier.

Below is an example of a digital TV signal:

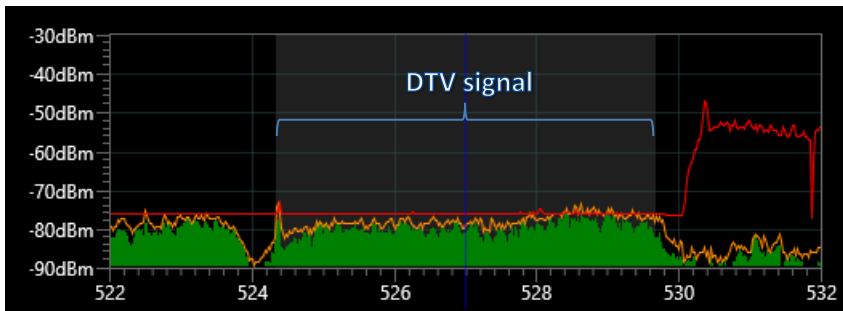

DTV signal in ATSC format (USA, channel 23)

The bandwidth of a DTV signal can vary from 6 to 8 MHz in different countries.

When demodulated, a DTV signal will have typical "noisy digital" sound in the AM and FM modes.

FM radio

The bandwidth (BW) of an FM signal may be 30 – 200 kHz, depending on reception conditions. The spectrum of a typical FM signal consists of one "peak":

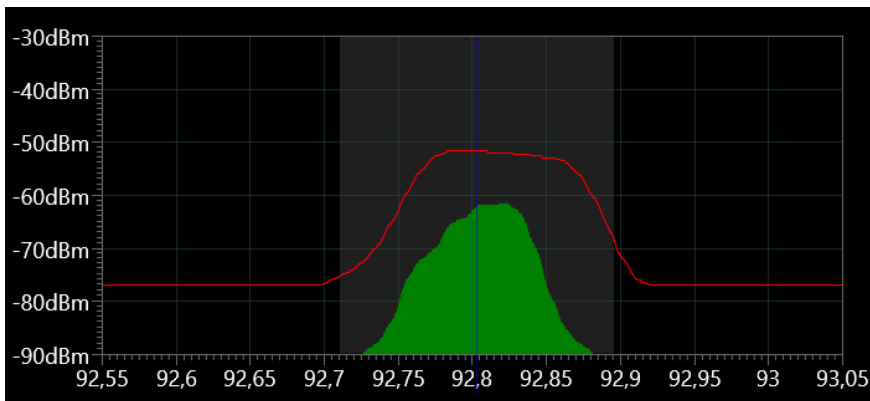

FM radio 92.8 MHz

An FM signal can be listened to in the "FM demodulation" mode.

High definition (HD) radio

HD radio transmits extra information and therefore occupies a wider bandwidth of up to 400 kHz. It is recommended to select a 400-500 kHz bandwidth for any HD radio signals in the Known Signals table.

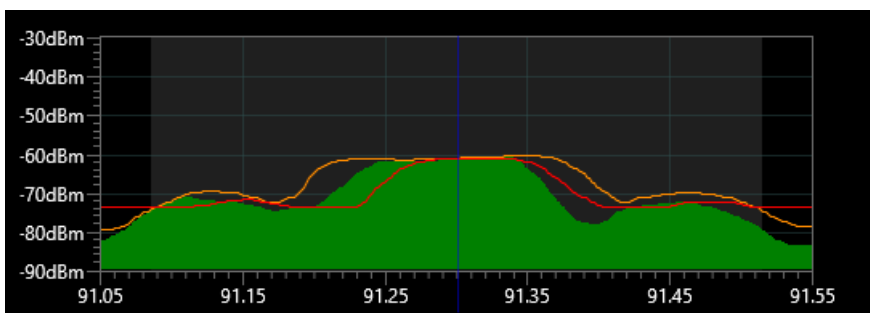

HD radio in USA, 91.3 MHz

The signal has 2 additional sidebands each transmitting digital information, while the central carrier can be easily listened to in the "FM demodulation" mode.

Other signals

In the area of sweeping there might be a number of VHF and UHF radio signals sent by taxi services, police, federal, military, aircraft, air traffic, marine, amateur and public safety.

The signals might be sent by a base trunking station and exist continually. Or they can have periodical activity when transmitted by a portable or mobile transceiver.

After identification these signals can be added to the Known Signals table with the help of the "Add to known" and "Enter manually..." buttons. A unique name should be assigned to each new record.

Guard 24/7

There are a number of hidden bugging devices transmitting signals non-constantly:

- Radio microphones or video cameras activated remotely
- GSM/3G/4G(LTE)/5G bugs activated by an external request
- Bugging devices with accumulation and periodical uploading of information

Such types of bugs transmit radio signals just periodically - during an important meeting, negotiations or whenever necessary. An audio accumulating bug can store conversations during days and then upload the data within a few minutes at a pre-programmed time or under an external request.

The Guard 24/7 mode was created for the day-and-night guarding of the target zone in order to detect all types of signals including non-constant ones and provide the highest level of security.

There are some differences compared to the RF Sweep mode:

- The system has a lower alarm rate thanks to the rejection of short transmissions
- The reaction time depends on the signal's power and bandwidth
- The operator can use the special mode with 2 wideband antennas

Gaining experience in the RF Sweep mode is recommended before using the Guard 24/7.

Reaction time

Since the short signals from remote controls, wireless alarm sensors and VHF/UHF communications are considered to be safe the Guard 24/7 rejects them. In this mode a signal should exist and exceed the threshold during a certain time in order to become dangerous.

The reaction time depends on the signal's power and bandwidth. The stronger signals with a wider bandwidth produce an alarm faster, usually within 3-5 seconds. The weaker narrowband signals should exist for at least 5-10 seconds to produce the alarm.

Please note that the short-burst signals like DECT, Wi-Fi, GSM, 4G/LTE, 5G, etc. are detected in the Guard 24/7 mode.

Initial parameters

The parameters page appears when the "Guard 24/7" mode is selected. All the options are similar to the "RF Sweep" mode except for the additional option in the "Use of antenna" selector: **"2 wideband antennas: 1) in the target zone; 2) in a remote place"**. This variant is applicable to the static use only. The Delta X can guard the target zone for a long time and adapt to the RF environment by updating the masks automatically. The antennas are placed inside the target room and in a remote area. This method decreases the rate of false alarms since the signals are checked on both antennas and the stronger responses on the local antenna are marked as dangerous only.

The set needed for this method is supplied separately. The Option '001' includes one wideband antenna ODA-4 and two 20 m extension cables. Both ODA-4 antennas, one from the Delta X and the other from the Option 001, should be connected via the 20 m extension cable.

Usage of 2 wideband antennas

- The main wideband antenna should be put within the target zone (in the checked room)
- The remote wideband antenna should be as far from the target zone as possible (not closer than 15-20 meters)
- The remote antenna should be able to receive the broadcasting and other external signals with high sensitivity. The optimal placement is near a window.
- Both antennas should be used with similar extension cables to equalize the attenuation, not depending on the position of the system.
- The system can be placed in any convenient place, within the target zone or in an adjacent room
- The main antenna should be connected to the INPUT. The remote antenna should be connected to AUX (AUX1).

In case of organizing a permanent control post and running through its own cables, use the following 50 Ohm low-attenuation cables: LMR-240, 5D-FB (6-7 mm), RG-8, RG-213, LMR-400 (10 mm), LMR-600 (14 mm).

The RG-58 and other high loss cables cannot be used.

Do not exceed 30-50 meters length. Use the same cable length for the main and remote antenna.

If possible, the remote antenna can be placed in the roof area or at least in a window to provide the best reception of broadcasting.

Example of antenna placement:

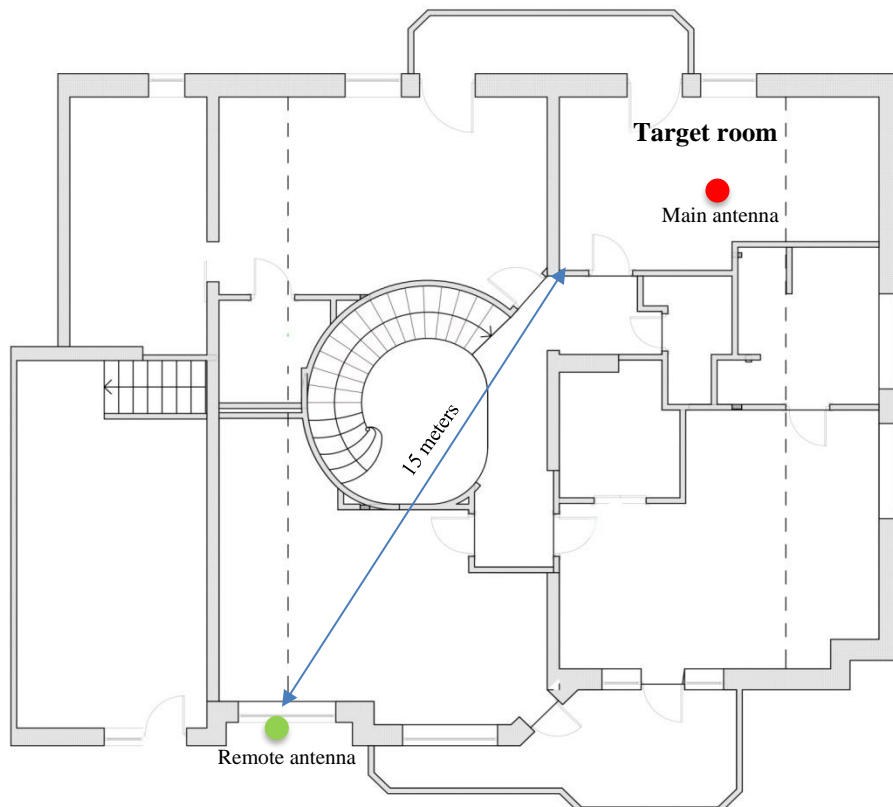

Antenna connections

Connect the antennas in accordance with the "Antenna connection" box.

When it is necessary to make a location procedure or study a suspicious signal, stop the detection temporarily and enter the Signal Analyzer mode. Connect the antennas as in the standard "RF Sweep" mode temporarily.

Detection process

When the Guard 24/7 is started with the 2 "in target" and "remote" antennas, the system works under the following algorithm:

- After the start, the "Update Masks" procedure is performed automatically on the remote antenna during 1 minute
- The main antenna is selected and the spectrum traces are fetched
- If dangerous signals are detected on the main antenna, the mask updating procedure on a remote antenna is repeated with a frequency of once per 30 seconds
- Some external "false" signals can be eliminated in this mode thanks to the quick mask updating

It is necessary to take into consideration that the sensitivity on higher frequencies may drop in the special mode "2 wideband antennas: 1) in the target zone; 2) in a remote place". This is caused by a certain attenuation in the cables and the absence of the microwave antennas. It is recommended to conduct a standard search in the "RF Sweep" mode periodically.

Car Tracker Detector

GPS trackers

A GPS tracking unit is a device, normally carried by a moving vehicle or person, that uses the Global Positioning System to determine and track its precise location, and hence that of its carrier, at intervals. The recorded location data can be stored within the tracking unit, or it may be transmitted to a central location data base, or Internet-connected computer, using a cellular (SMS or internet packets), radio, or satellite modem embedded in the unit.

Usually, a GPS tracker will fall into one of these three categories:

- Data logger. Logs the position of the device at regular intervals in its internal memory.
- Data pusher (most common type, also known as a *GPS beacon*). This kind of device sends the position of the device at regular intervals, to a determined server, which can store and instantly analyze the data.
- Data puller (also known as *GPS transponders*). Sends the position under external request only. This technology is not in widespread use and can be used in the case where the location of the tracker will only need to be known occasionally e.g. placed in property that may be stolen, or that does not have constant source of energy to send data on a regular basis, like freights or containers.

The data pusher, sending the coordinates periodically and using the cellular networks is the most popular type of GPS tracker used nowadays. The data is sent via the GSM, 3G, 4G/LTE or 5G networks.

The Delta X can detect data pushing GPS trackers by detecting their periodical exchange with the mobile network.

Algorithm of detecting the periodical exchange

Unlike the RF Sweep mode which detects all types of signals, the Car Tracker Detector mode is concentrated on measuring activities on the cellular bands only. The other frequency ranges are not scanned. Since the spectrum analyzer does not scan other frequencies, the update rate and the probability of detection are higher and the reaction is quicker.

The bands to be monitored in the Car tracker detector are selected in the Settings – Bands. The "Tracker detection" check box allows the user to include the desired bands. It is recommended to include all the cellular uplinks and exclude the downlinks and the wireless bands like Wi-Fi and DECT. The 4G/LTE (5G) bands of a "Shared" type should be included as well.

The Delta X system must be placed inside the checked vehicles. The detection algorithm is as follows:

- All personal mobile phones and other carried cellular devices must be switched off or placed into flight mode
- All the known cellular devices built in the car (alarm systems, traffic statistics senders, etc.) should be deactivated (switched off). If necessary, contact a service center for turning them off temporarily
- Go to a secondary road in the country to avoid external interferences. Start the Car tracker detector mode. Like the other detection modes, the Car tracker detector allows the user to select the log. Press the Start button to begin.
- Typically trackers have a movement sensor; therefore the vehicle should move in order for the tracker to be detected. Drive along secondary roads omitting cities, high traffic areas or crowded places in order to avoid interferences from other external cellular devices
- Since the frequency of the coordinate's upload is unknown, driving and simultaneously measuring for at least 1-2 hours is recommended.

Note: A car's power point can be used to power the Delta X's laptop

- The periodical activity in the GSM, 3G, 4G/LTE or 5G bands with a moderate to high level may be a sign of a GPS tracker. Watch the Alarms graph. The frequency of exchange may be every 10 seconds or 30 seconds or 5 minutes, for example.
- In case of a large-sized vehicle repeat the test with the Delta X or its antenna placed in another part of the car. Keep watching the danger level and the Alarms graph
- The dBm threshold for the bands can be adjusted to achieve the best balance between the sensitivity and any false detections. Typically for GSM it is not necessary to set a very high sensitivity so the threshold can be between -60...-30 dBm in order to reject any external signals. 3G, 4G/LTE or 5G will demand the setting of a higher sensitivity with the threshold's level at -85...-70 dBm.
- The Alarm threshold can be adjusted when necessary

It is also possible to analyze the results later by reviewing the log.

Below is an example of a GPS tracker sending signals on the DSC-1800 band :

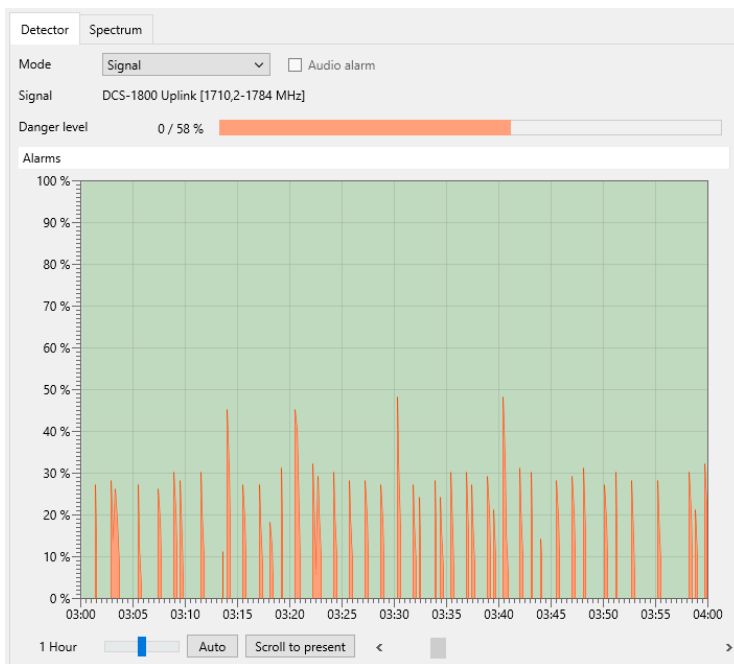

Location change algorithm

There is another approach to detecting data pusher and data puller types of GPS trackers.

In addition to the periodical exchange (data pushing), the GPS tracking devices communicate with the network when they change an area. The mobile network's base stations are combined into areas with a unique code. When a cellular device enters the area with another code it issues a location update request, thereby informing the mobile provider of its new position. This allows the provider to locate the cellular device in case of an incoming call.

If the GPS tracker does not perform periodical exchanges, the presence of a strong signal when the vehicle is crossing the coded area's border may discover the tracker.

The size and the borders of the coded area are unknown, but it can be supposed that if a vehicle moves 20-50 km in one direction the probability of changing the coded area and appearing of the data exchange will be high. If there is an activity in a certain place, the test may be repeated in the reverse direction in order to check if the activity occurs again.

A high danger level may last 3-5 seconds in case of the presence of a "hidden in the vehicle" cellular device. Presence of a cellular device may be a sign of a GPS tracker.

While the Car Tracker Detector discovers the most popular GPS trackers on the move, the RF Sweep mode can find hidden devices of other types: beacons sending data by other means (Satellite/Wi-Fi/VHF/UHF), bugs/radio-microphones, wireless cameras, etc. Additional usage of the RF Sweep mode is recommended for a full check of the vehicle.

Stop / View Log

A log is a database which stores data collected during the detection process. In the Stop / View Log mode the operator reviews the results of detection without performing new measurements.

Selecting log and date

The Stop / View Log can be pressed anytime during the detection so that the current log for the present date can be reviewed. At the same time, it is possible to select any other log or date later, using the **log selection button**.

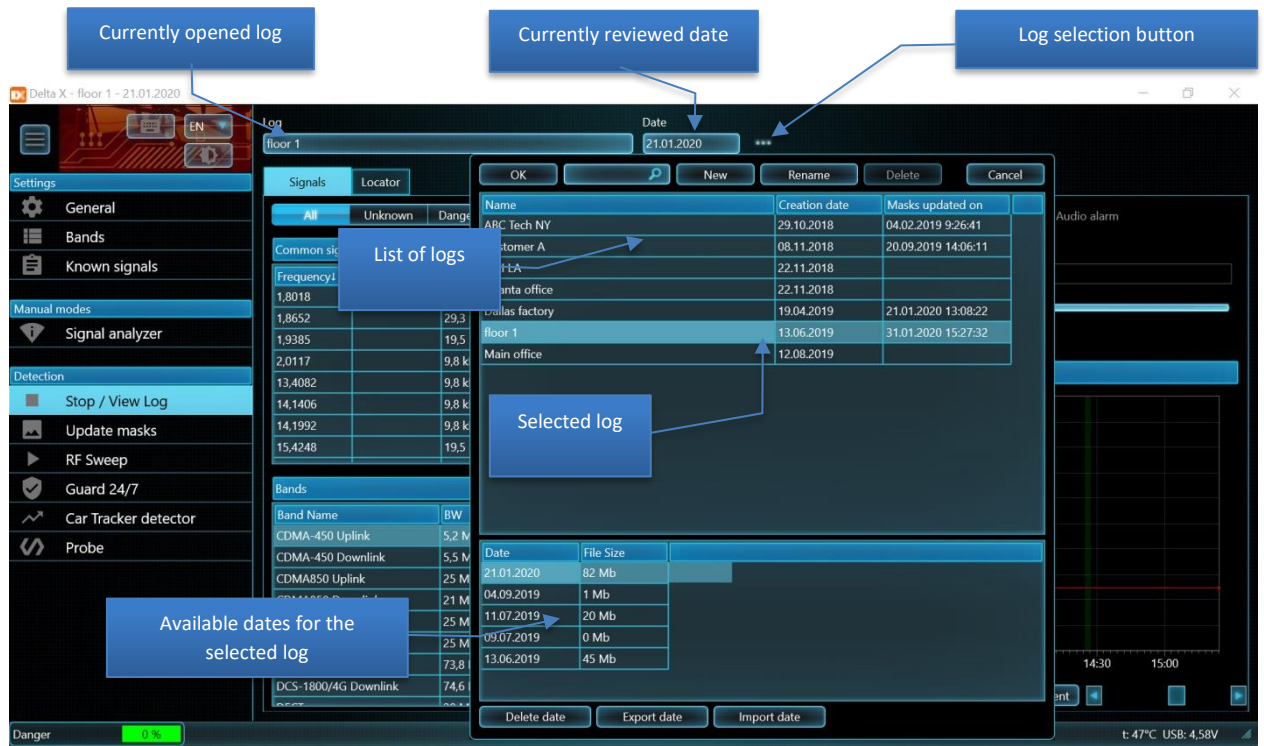

The upper part of the log selection window contains the **list of logs**, whereas the bottom part displays the **list of dates** available for the selected log.

The information in the logs is split into dates. When the detection is started on another day, a new date is created. If the detection is performed continually, the Delta X system creates a set of dates. A new date is created at midnight.

Press the log selection button, select the log, date and press **OK** to open. It is also possible to open the log by double-clicking it or the desired date.

The "**File Size**" reflects the occupied disk space (by the date).

It is possible to delete a separate date with the help of the "**Delete date**" button. The entire log and all its dates can be erased at once by the "**Delete**" button in the upper toolbar. A currently open log and date cannot be deleted.

The "**Export date**" and "**Import date**" buttons can be used for backup and reviewing the detection results of another Delta X system.

Viewing signals and alarms

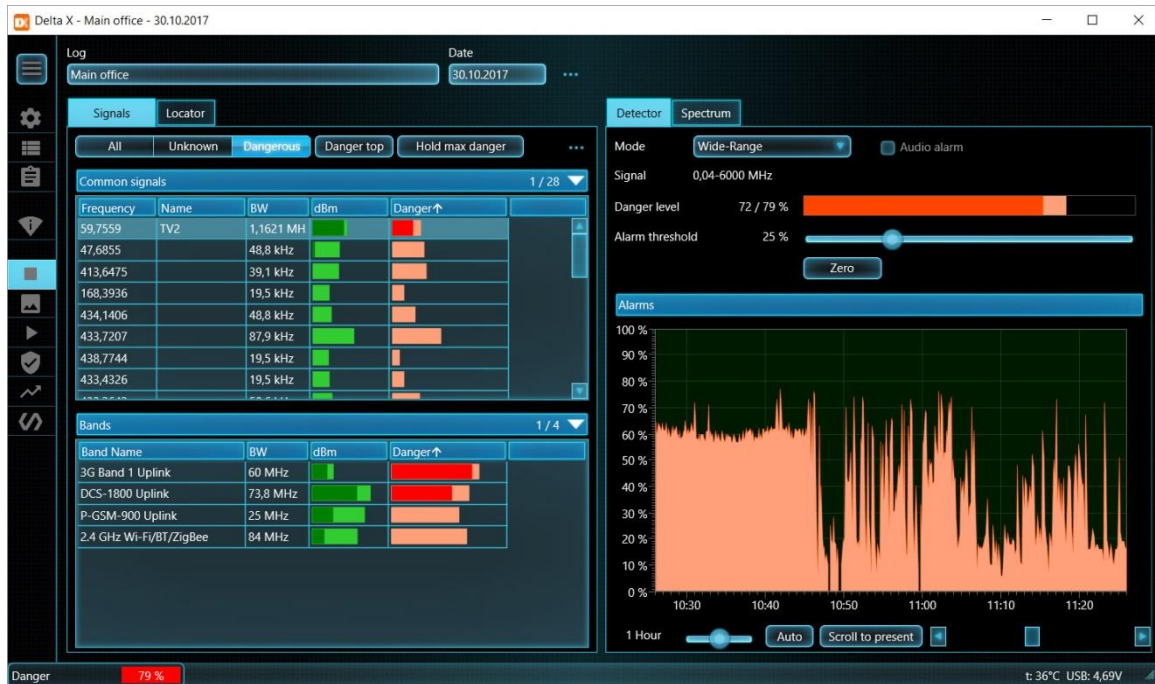

The Stop / View Log mode gives information about the detected signals to the operator. The task of the operator is to study the dangerous signals, alarms and to go to the Signal Analyzer for locating or saving the signal to the Known Signals table.

The Signals table shows the list of detected signals. All the standard operations with the signals are available in this mode: filtering, sorting, etc.

The Danger field represents the maximum danger level of the signals (light red) measured during the last detection. Use the Dangerous filter and the Danger top button to quickly select the most dangerous signals.

When the mode of the Detector is Wide-Range, the Danger level bargraph shows the maximum alarm from all the signals, while the Alarms graph shows the distribution of alarms in time.

When the mode of the Detector is Signal, the Danger level bargraph represents the maximum alarm from the selected signal, while the Alarms graph shows the distribution of alarms in time for the signal.

There are two ways of reviewing the logged information:

- 1) Inspection of dangerous signals in the Signals table one by one, and reviewing the alarms of each signal on the Alarms graph with the Detector in the Signal mode:
 - Set the signal's filtering as Dangerous
 - Set the Detector's mode as Signal
 - Click, or double-click, the signal in the Signals table. The Alarms graph will show the alarm events created by the signal
 - Click the events on the Alarms graph. The Waterfall and Spectrogram will show the corresponding time, while the dBm and Danger columns in the Signals table will reflect the levels which existed at the time of clicking
 - A click on the Waterfall will display the corresponding measurement in the "Live trace" on the Spectrogram

- 2) Inspection of the Alarms graph with the Detector in the Wide-Range mode, clicking on the alarms and reviewing what signals created them:
- Set signal's filtering as Dangerous
 - Set the Detector's mode as Wide-Range
 - Click the alarm events on the Alarms graph. The dBm and Danger columns in the Signals table will reflect the levels which existed at the time of clicking. The Danger column will show what signals created the alarm at the moment of clicking. The Locator will display the dangerous signals at the clicked point.
 - Click, or double-click, the dangerous signals in the Signals table or Locator and review the activity in the Spectrogram and Waterfall
 - A click on the Waterfall will display the corresponding measurement in the "Live trace" on the Spectrogram

The Alarms graph can be clicked in order to select the corresponding time in the Waterfall.

Below is an example of the intermittent danger signal 433,9307 MHz. The bargraph is showing a 37% peak danger level, while the Alarms graph displays the moments of activity.



When the Auto button in the bottom toolbar is in the pressed position, the Alarms graph automatically changes the displayed time span to show all the available alarms.

The Locator displays the dangerous signals which were active at the moment the Alarms graph was clicked on. The Spectrogram page allows the operator to see the spectral information. Below is an example of the same 433,9307 MHz signal:

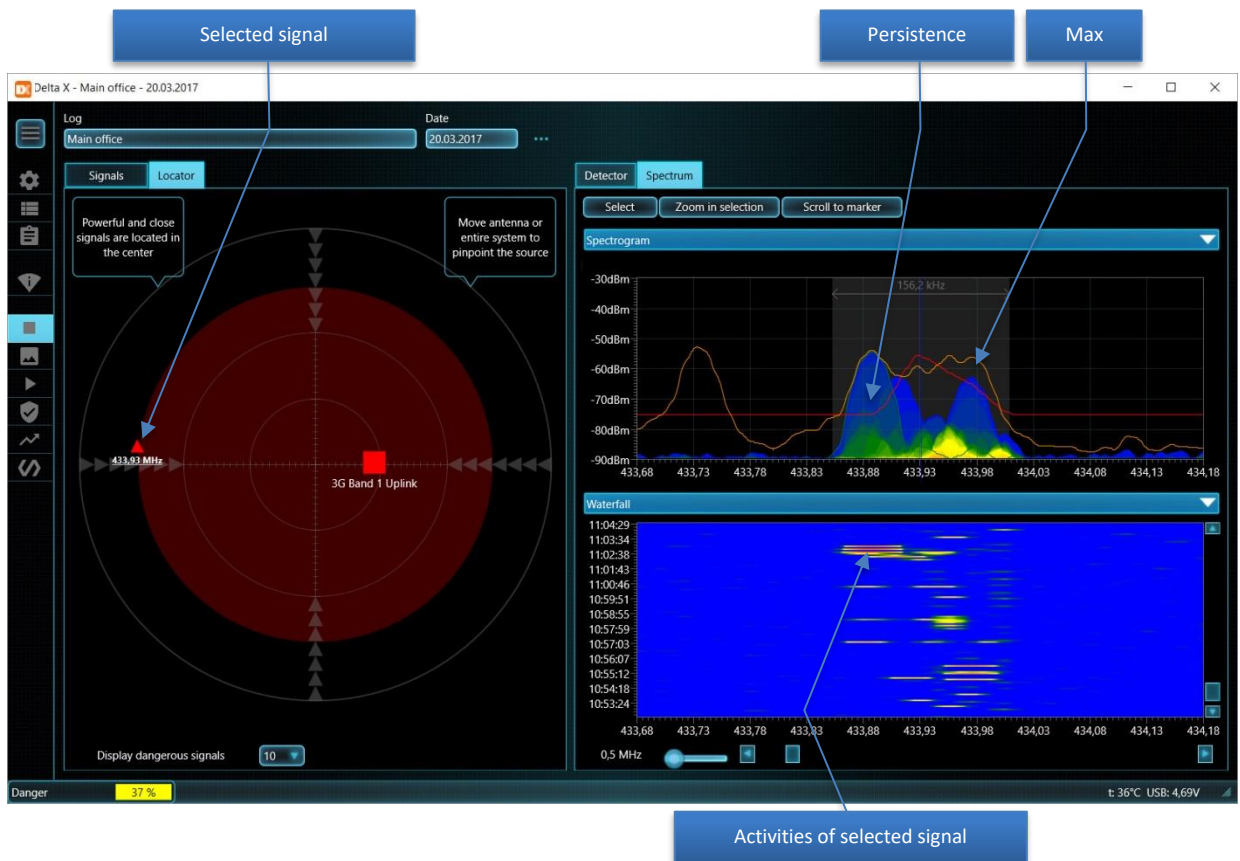

The Persistence rendering (shown on the above example) draws the spectrum by a changing color depending on the activity of signal. Depending on your needs, the Persistence or Live can be activated.

The orange Max shows the maximums accumulated during the detection. The maximums are convenient for learning intermittent signals as they keep the information even if the signal is not active at the moment of reviewing the results.

The Waterfall allows the operator to see the changes of signals in time. While the Alarms graph shows the danger level, the Waterfall displays the dBm level by color. By clicking on the Waterfall it is possible to view the spectrum trace taken at the moment corresponding to the position of the click on the vertical time scale. The Live will show the clicked trace.

Adjustment of the Waterfall's density will help to set the displayed period, while scrolling it vertically sets the starting moment. It is also possible to scroll the Waterfall by clicking the needed time in the Alarms graph (Detector page). The Waterfall data defines what is shown in the Persistence.

To inspect the signal's history during other days, open the needed date in the log selection window.

To study a signal's spectrum in the present time, demodulate and locate the transmitter use the Signal Analyzer mode.

Probe

The transmission of information through wires is supposed to be more covert since there are no easy-to-detect radio waves produced. Practically any wire lying within, or crossing the target room and further going outside the area can be used for surveillance as a transmission means. A line carrier bugging device will consist of 2 units: a transmitter located within the target area and connected to the wire and a

receiver outside the target area connected to the same wire. The transmitter picks up the audio within the room, converts it up to a higher frequency and sends the signal via the wire. The receiver picks up the signal from the wire, converts it down and passes the audio to the voice recorder or monitoring post. The signal can be sent via any type of wire while leaving it operable.

In addition to the law enforcement grade line carrier bugs, it is necessary to take into consideration the powerline networking technology. A simple but hard-to detect bugging device can be built from an IP video camera with audio and a cheap powerline adapter streaming data over an AC outside the premises. Then the external powerline adapter picks up the sent information. The HomePlug AV/AV2 standards provide data throughput up to 500 Mbps and occupies the range between 2 and 86 MHz.

Infrared rays are invisible and distribute relatively long distances; therefore they can be used for surveillance too.

Some surveillance devices, or their parts, may emit electromagnetic waves: AC powered transmitters, video cameras, etc.

The Delta X can detect the above-mentioned ways of surveillance with the help of the Multifunction Probe which is supplied in the standard set.

Multifunction Probe, version 1:

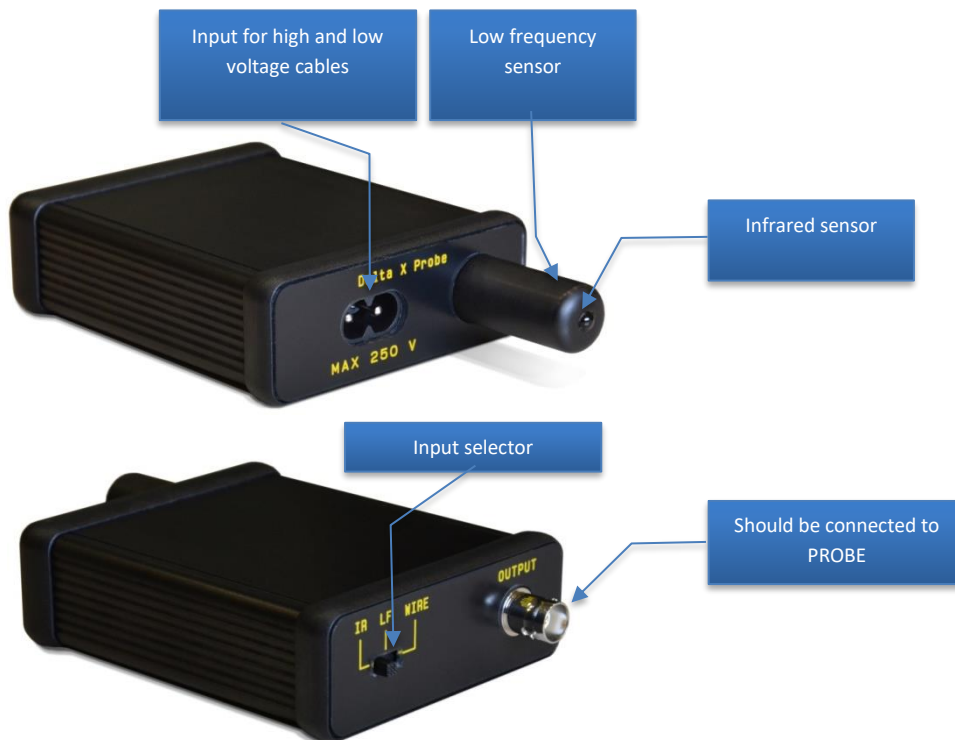

Multifunction Probe, version 2 (available from 1/05/20):



The probe has 3 inputs:

Input	What is detected
IR	Hidden infrared transmitters
LF	Electromagnetic emissions from bugging devices
WIRE	Bugging devices sending information over: <ul style="list-style-type: none"> • AC wires • Ethernet • Landline telephone wires • Alarm cables • Other low-voltage cables

The Delta X software will have the following view in the Probe mode:



The Signals table shows the Common signals section and hides the Bands. The Spectrogram's and Waterfall's span is initially set to display the range 0 - 10 MHz, although it is possible to change the span and scroll to any frequency.

The first toolbar's line contains the same controls which are present in the Signal Analyzer mode: Watch Mode selection (Spectrum or Demodulate), Update Span selection, Number of readings and Frequency.

The second toolbar's line contains controls specific to the Probe mode.

Unlike the other detecting modes the Probe mode does not store the signals in the Signals table after work is completed. The Signals table and the Waterfall are cleared each time the Zero button is selected.

The "**Attenuator**" function can be used when a strong signal is met and the "overload" message appears constantly (usually when checking the AC wires).

The "**Zero**" function rejects the signals currently being received by the Multifunction Probe. The rejection is performed by storing the current spectrum trace for its subsequent extraction. The use of the function is described for each further input. The Signals table and the Waterfall are cleared each time the Zero button is pressed.

The "**0-2 MHz**", "**0-10 MHz**" and "**0-100 MHz**" buttons set the standard spans:

- "0-2 MHz": is recommended for the IR and LF input
- 0-10 MHz: is recommended for the WIRE input
- 0-100 MHz: is recommended for the WIRE input when it is necessary to inspect the line in a wider frequency range

Any span can be selected manually in the Spectrogram. Please note that despite the spectrum graphs display, the span starting from 0 means the actual measured range begins at 9 kHz or 100 kHz, depending on the system's version.

Like in all other modes **double clicking** on a signal in the Signals table performs tuning it in. The spectrum graphs adjust automatically to show the clicked signal fully. If the Detector is in the Signal mode it will be assigned to the clicked signal. A single click tunes in a signal without adjusting the spectrum graphs.

Clicking on the Spectrogram allows tuning in the desired frequency.

The Persistence view of the Spectrogram, when activated, allows the user to distinguish between the continuous and non-constant signals.

Infrared (IR)

Since infrared rays have a directed nature, the potential IR bug will be directed to the place of the signal's reception. The most likely direction will be the outer area near the building or a remote part of the room. The detection should be performed inside the room and in the windows' area, with the Multifunction Probe pointed to the interior of the room, window frames and the area near the frames.

The detection distance of the probe's IR sensor depends on the transmitter's power and can be 1-5 meters, on the condition of being pointed to the source.

Algorithm

1. Connect the Multifunction Probe to the PROBE with the help of the supplied 5m coax cable
2. Select the IR input on the probe
3. Select the Probe mode in the Delta X software
4. Create a source of sound in the room to activate any potential bugging devices
5. Point the probe's IR sensor to the place of possible bugging (for example, from outside the window to the interior and frames)
6. If an infrared signal is detected, it will be automatically inserted into the Signals table.
7. In case of finding a signal, rotate the probe in different directions in order to find the strongest level, which will mean that the sensor is directed to the transmitter. Move the probe closer to the supposed source while observing the change of level. Try to find the place with the highest danger level. The Audio alarm function will change the intensity of sound correspondingly. In the place where the strongest level is found start a physical inspection. If the entire area produces a low to average level of danger, and there is no one place with a strong signal, it may mean just the presence of interference.
8. Repeat the test near other windows and parts of the room

Low frequency (LF)

The LF sensor of the Multifunction Probe allows the operator to find signs of hidden working electronics by detecting radio-frequency emissions.

The detection distance is up to 30 cm; therefore objects and surfaces must be probed carefully.

Algorithm

1. Connect the Multifunction Probe to the PROBE with the help of the supplied 5m coax cable

2. Select the LF input on the probe
3. Select the Probe mode in the Delta X software
4. Create a source of sound in the room to activate any potential bugging devices
5. Start scanning the area (objects, surfaces, constructions, etc.) while observing the change of the danger level. The Audio alarm function will produce sound of changing intensity, depending on the level.
6. All the signals (parts of spectrum exceeding the threshold) will be inserted into the Signals table automatically. Their dBm and Danger levels will be updated during the search
7. Try to find the source of the highest signal by moving the probe in different directions. High current-consuming electronics in a working state will create a high level with a specific spectrum form. It is normal that metallic objects and construction re-emit the RF fields, sometimes producing a danger level.
8. Use the demodulation when it is necessary to inspect a suspicious signal. To do so select the signal in the Signals table or click the peak on the Spectrogram. The probe should stay near the source during this operation. Some electronic devices can have recognizable sound helpful for detection.

AC wires (WIRE)

Since the AC wire is an antenna itself, it receives a lot of RF emissions present in modern environments. The different method described below helps to avoid the sophisticated process of finding a suspicious signal among a huge number of interferences. With this method the Delta X stores the RF environment measured in the first AC outlet and extracts it further from the others. When probing other outlets the operator will observe the difference. Therefore, if a bugging transmitter is present somewhere on the AC line, its signal will grow as the Multifunction Probe is moved closer to it. This different method helps to detect signals by probing a series of AC outlets connected to the same AC wire.

Algorithm:

1. Connect the Multifunction Probe to the PROBE with the help of the supplied 5m coax cable
2. Select the WIRE input on the probe
3. Select the Probe mode in the Delta X software
4. Connect the high voltage cable to the Multifunctional Probe.

Warning: NEVER USE THE LOW-VOLTAGE "ALLIGATOR" CABLE FOR PROBING AC WIRES.

5. Create a source of sound in the room to activate any potential bugging devices and recognize them during demodulation
6. Connect the high voltage cable to the AC outlet #1 in the room
7. Press the Zero button
8. Connect the high voltage cable to the other AC outlets in the room one by one and watch for any new signals. Interference signals typically do not have a strong peak or occupy a wider span and may be present in a number of outlets, while a real transmitter will have a stronger level only on the separate outlets.
9. Observe and learn the detected signals:
 - Double-click or click the signals in order to review them in the spectrum graphs
 - Select "Demodulate" in Watch Mode

- Click on all peaks within the Spectrogram in order to tune in precisely and listen to the signal. Try to recognize signs of modulation. Change the demodulation mode and bandwidth if necessary. Change the frequency slightly.
 - In case of finding a modulated signal within the audio of the room, or a signal with an untypically strong level, start a physical inspection along the suspicious wire.
10. To avoid masking a bug, if it is present in outlet#1, repeat steps 7-10 selecting another outlet as #1 and probing all others once again

Example of detecting an audio bug sending a signal over an AC line:

AC outlet #1



AC outlet #1 after pressing Zero

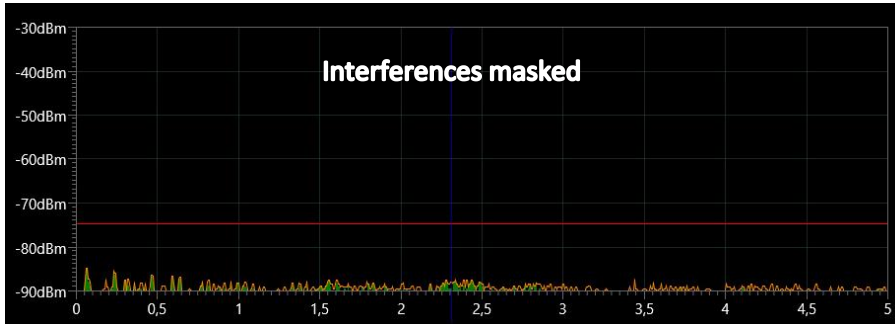

AC outlets #2...5 – no danger, low level of interferences

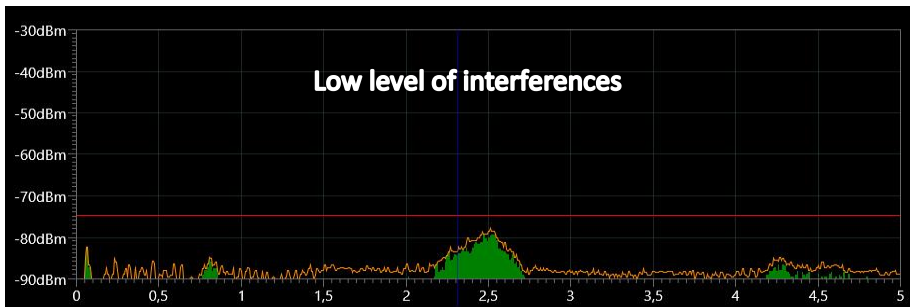

AC outlet #6 – the first sign of danger



AC outlet #7 - BUGGED

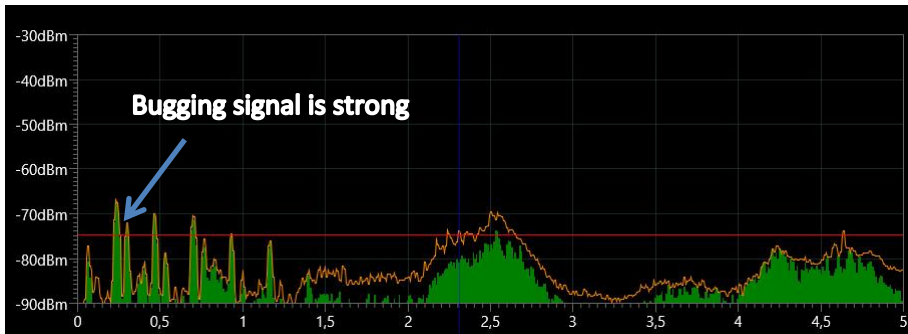

Low-voltage wires - Telephone, Ethernet and alarm (WIRE)

The Delta X is supplied with the following accessories allowing the operator to test low-voltage wires:

- Low-voltage cable with "alligator" connectors
- In-line modular adapter
- Adapter "8 pin male to 6 pin female"
- Adapter "8 pin male to 4 pin female"
- Connection cable "8 pin to 8 pin"
- Connection cable "8 pin to 6 pin"
- Connection cable "8 pin to 4 pin"

For each type of wire a specific adapter should be used:

Wire	Connection type	Needed accessory	Terminals
Landline phone	RJ-11 (6 positions, 4 conductors)	Low-voltage cable, modular adapter, cable 8-to-6, adapter 8-to-6	1...4
Landline system phone	RJ-12 (6 positions, 6 conductors)	Low-voltage cable, modular adapter, cable 8-to-6, adapter 8-to-6	1...6
Ethernet cable	RJ-45 (8 positions, 8 conductors)	Low-voltage cable, modular adapter, cable 8-to-8, adapter 8-to-8	1...8
Alarm cables	Direct (alligator connector)	Low-voltage cable	

Other low-voltage cables	Direct (alligator connector)	Low-voltage cable
--------------------------	------------------------------	-------------------

Algorithm:

1. Connect the Multifunction Probe to the PROBE with the help of the supplied 5m coax cable
2. Select the WIRE input on the probe
3. Select the Probe mode in the Delta X software
4. Connect the low voltage "alligator" cable to the Multifunctional Probe.
5. Create a source of sound in the room to activate any potential bugging devices and recognize them during the demodulation
6. Connect the low-voltage "alligator" cable to the wire. If necessary use the in-line modular adapter and accessories:

Landline phone

The connection to the telephone can be made either at the phone set side or near the wall socket, depending on accessibility. Insert the male-to-female adapter into the modular adapter tightly to provide the proper connection. Make sure the telephone stays operable after the modular adapter is connected in-line. Below is an example of probing the phone line near the phone set.

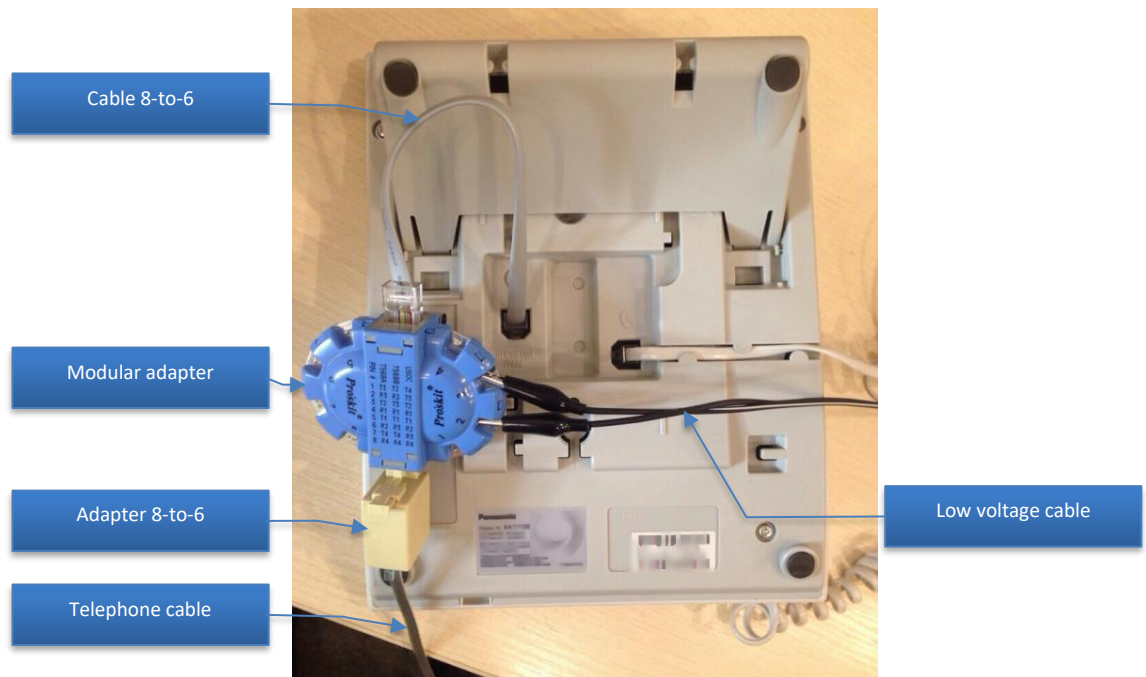
**Ethernet**

The connection to the Ethernet can be made near the computer, wall socket or near the network equipment (switch/router). Insert the male-to-female adapter into the modular adapter tightly to provide the proper connection. Make sure the network stays operable after the modular adapter is connected in-line. Below is an example of probing the Ethernet at the computer:

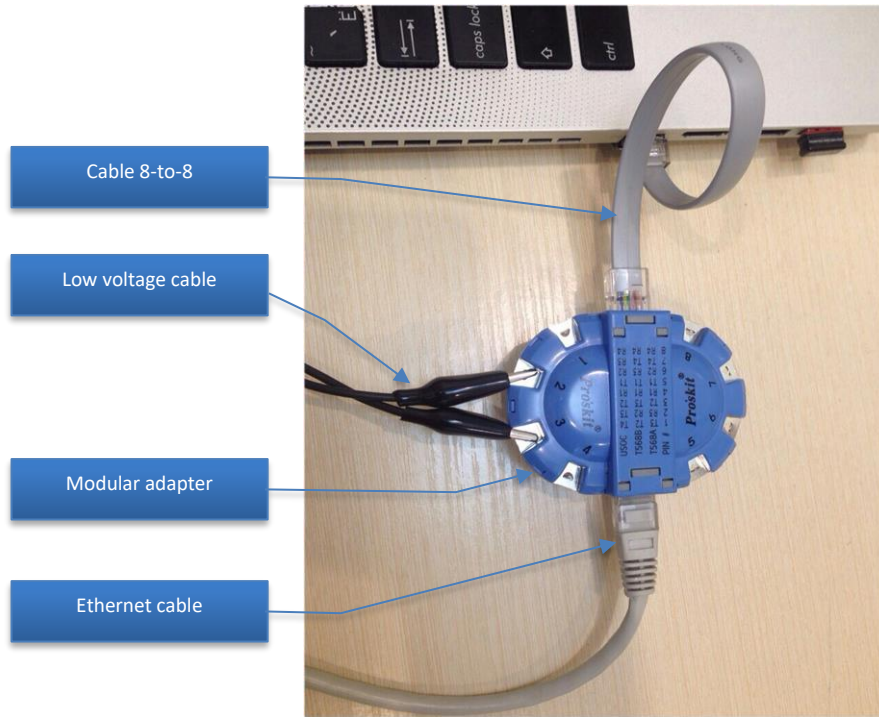

Alarm and other low-voltage wires

Connection to other low-voltage lines, including alarm systems should be made with the help of the low-voltage cable with alligator connectors.

The alarm movement detector should be disassembled in order to reach the terminals. The procedure can be made on the control panel as well.

Please note, that alarm detectors, fire detectors and control panels are mostly tamperproof, i.e. they alert the alarm monitoring center about disassembly. The procedure should be agreed with the central monitoring station and performed with the presence of a technician.

7. Connect the alligator connectors to the terminals on the modular adapter in accordance with the quantity of used conductors. The telephone lines may use 2, 4 or 6 conductors, while the Ethernet employs 4 conductors from the 8 present in the twisted pair cable.

The modular adapter uses the following numeration of the terminals:

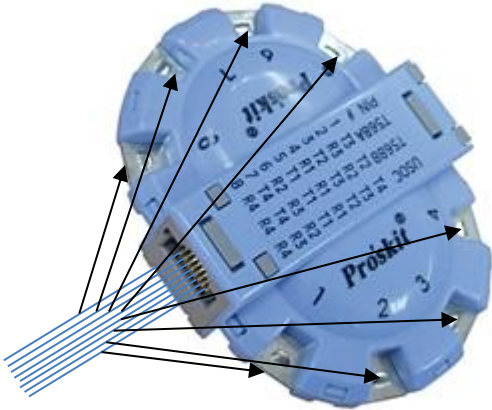

Since it is often unclear what particular conductors are used, all the combinations of the alligators can be used for checking the line: 1 and 2, 2 and 3, 3 and 4, 1 and 3, 1 and 4, etc. The spectrum may coincide in some pairs.

8. After connecting the alligators the measurement will start. The signals exceeding the threshold will be automatically inserted into the Signals table. Turn off the Audio alarm function if necessary or adjust the Alarm threshold.
9. Observe and learn the results of detection:
 - Double-click or click the signals in order to review them in the spectrum graphs
 - Select the Demodulate in the Watch Mode
 - Click on all peaks within the Spectrogram in order to tune in precisely and listen to the signal. Try to recognize signs of modulation. Change the demodulation mode and bandwidth if necessary. Change the frequency slightly.

Please note that since the wire is an antenna itself it receives a lot of RF emissions present in our modern environment. Detection of interference signals is a normal situation. The task of the operator is to study all the signals in the Signals table and the spectral peaks in the Spectrogram, analyze the levels, demodulate and make a decision about their safety.

- In case of finding a modulated signal with the audio of room or a signal with an untypically strong level start a physical inspection of the suspicious wire.
10. If you are checking the phone line, perform the test off-hook and hung up
 11. Repeat the test for all the combinations of pairs on the modular adapter, reconnecting the alligators as necessary
 12. Repeat the test for other telephone lines/Ethernet sockets present in the target room and in the adjacent rooms.
 - The interference signals might have approximately the same spectrum and strength on all lines, while the bugged line will have different spectrum view and signal strength
 - If a bugging signal is transmitted in a digital representation, it cannot be demodulated. At the same time, a strong signal and an untypical form of spectrum might point to danger.

Since the normal, non-dangerous signals are passed through the telephone and Ethernet wires the process of detecting danger among the normal signals may be difficult. It can be significantly simplified

with the help of the differential method. In this case the normal signals can be eliminated so that the operator can easily detect only the new suspicious component in the line.

To do so, make measurements in a number of lines of the same type and belonging to the same PBX or switch. For example, if there are a number of telephone sockets in the room, you can measure them in line to find the difference. Or this can be Ethernet sockets.

Use the "Zero" when probing the first line to capture the RF environment in it. Then proceed with measurements on the other lines to detect the difference. Since telephone and Ethernet cables contain more than 2 conductors, make sure that the same pair of conductors is measured on the other lines.

Absence of new components is a normal situation, while the presence of new signal is a suspicious sign. In this case it is necessary to study the line and equipment connected to it.

Reporting

The "**Generate Report**" feature allows the operator to export the results of detection into a PDF file. The report fully describes the RF environment in the monitored zone by listing dangerous and non-dangerous signals and shows their activity in graphs "Alarms", "Spectrogram", "Waterfall" and "Persistence".

The function can be called upon from the popup menu in the "Signals" table (right click on a signal). The "Generate report" window will open and you will be able to specify the parameters of report:

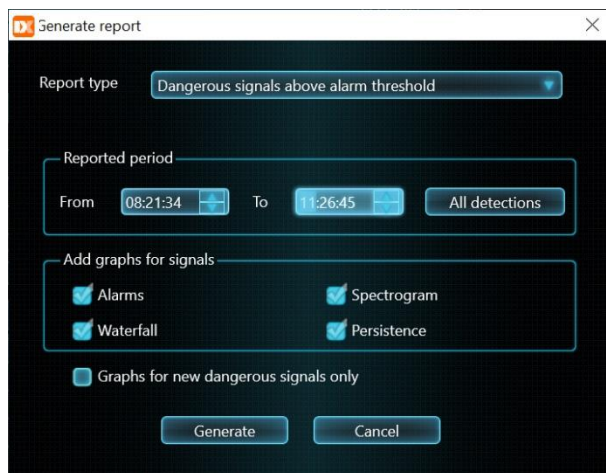

The '**Report type**' selects the desired type of report:

- **Dangerous signals above alarm threshold**
- a signal enters this report if its danger level exceeds the alarm threshold during the reported period. Set the alarm threshold in advance to cover more, or fewer, dangerous signals
- **All signals**
- all signals are listed in the report, including dangerous and non-dangerous
- **Selected signal**
- just the currently selected signal appears in the report

The '**Reporting period**' makes it possible to set the time interval for the report. By default, the "From" and "To" are initialized to include all detections in the log. The user can change them to a narrower interval in order to focus in on an interesting period.

The 'Add graphs for signals' checkboxes allows the operator to include graphs for each signal in the report: Alarms, Spectrogram, Waterfall and Persistence. Please note that as drawing the graphs is time consuming, it may slow down the report generation process.

The "Graphs for new dangerous signals only" allows the graphs for a limited number of signals only in order to optimize the generation time and decrease the size of file.

After the "Generate" button is pressed, the operator is offered to select the destination folder and the file name in the "Save File" window. Press "OK" to proceed.

After the process is completed the report will be displayed in the default viewer.

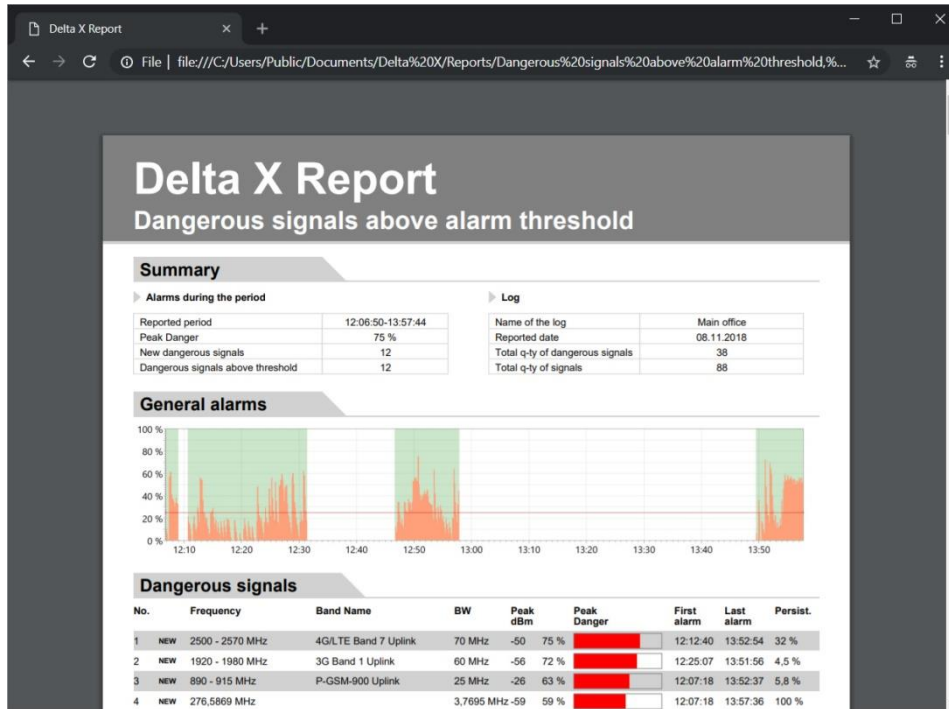

The **header** of the report includes the type of report.

The 'Summary' section lists some short information about the results of detecting:

- Reported period – the interval included in the report
- Peak Danger – the highest level of danger detected during the reported period
- New dangerous signals – quantity of dangerous signals detected during the reported period which were seen for the first time
- Dangerous signals above threshold – total quantity of signals producing danger within the reported period
- Name of the log
- Reported date
- Total q-ty of dangerous signals – the total quantity of dangerous signals including those not producing danger during the reported period
- Total q-ty of signals – total quantity of dangerous and non-dangerous signals

The 'General alarms' section shows peak alarms occurring during the reported period from all signals. The graph displays general the RF situation in the guarded area. The depicted scale depends on the reported period.

The '**Dangerous signals**' table lists the signals which were dangerous during the reported period and their attributes:

- The '**NEW**' mark is assigned to a signal which was dangerous for the first time during the reported period
- The '**Peak Danger**' reflects the highest registered level of danger for a signal during the reported period
- The '**first alarm**' is the time when a signal became dangerous for the first time
- The '**last alarm**' is the time of the last danger. Please note that the first and last alarms may be outside the reported period if a narrower reported period is selected
- The '**persistence**' shows how frequently a signal was dangerous during the reported period. 100% means constant activity, while a lesser value informs the signal was periodical. Short-time transmitters like remote controls, wireless signals, mobile signals and walkie-talkies may have a low persistence (near 1-2%).

The '**non-dangerous signals**' table is included in the report when the operator selects "All signals".

The following **graphs** are included in the report:

- The Alarms graph displays a signal's level of danger during the reported period. The depicted scale depends on the reporting period.
- The Spectrogram shows the spectrum trace logged at the most dangerous moment, if such danger exists
- The Waterfall shows the period of time around the highest level of danger, if it exists
- The Persistence shows the period of time around the highest level of danger, if it exists

The graphs are added for each signal or just for new dangerous signals according to the parameters being selected in the "Generate report" window.

Advanced possibilities for experienced users

Email notifications

This feature makes it possible to send notifications about detecting dangerous signals by email. The alerting message will contain information about the detected signals in the attached PDF report.

The message is sent when the level of danger exceeds the alarm threshold continuously for more than at least 10 seconds. The message is repeated every 5 minutes if the level of danger stays high.

The alerting feature becomes active 30 seconds after starting the detecting mode. The pause allows the operator to adjust the band's thresholds in the beginning to avoid unnecessary alerting messages.

2 additional notifications are sent - when the detection is started and stopped.

The PDF report attached to the alerting message includes the following graphs: Alarms, Persistence and Waterfall. The graphs are added to the new dangerous signals only (marked as NEW).

Since uncontrolled computers are easier to break into, email service providers may not allow the connection of the account to unknown applications. To guard your main email account the Delta X sends messages via a separate "sending" account which has the option to "allow access to less secure apps" to be turned on. If your "sending" account is hosted by gmail.com, enter its settings on gmail.com and activate the "allow access to less secure apps" option.

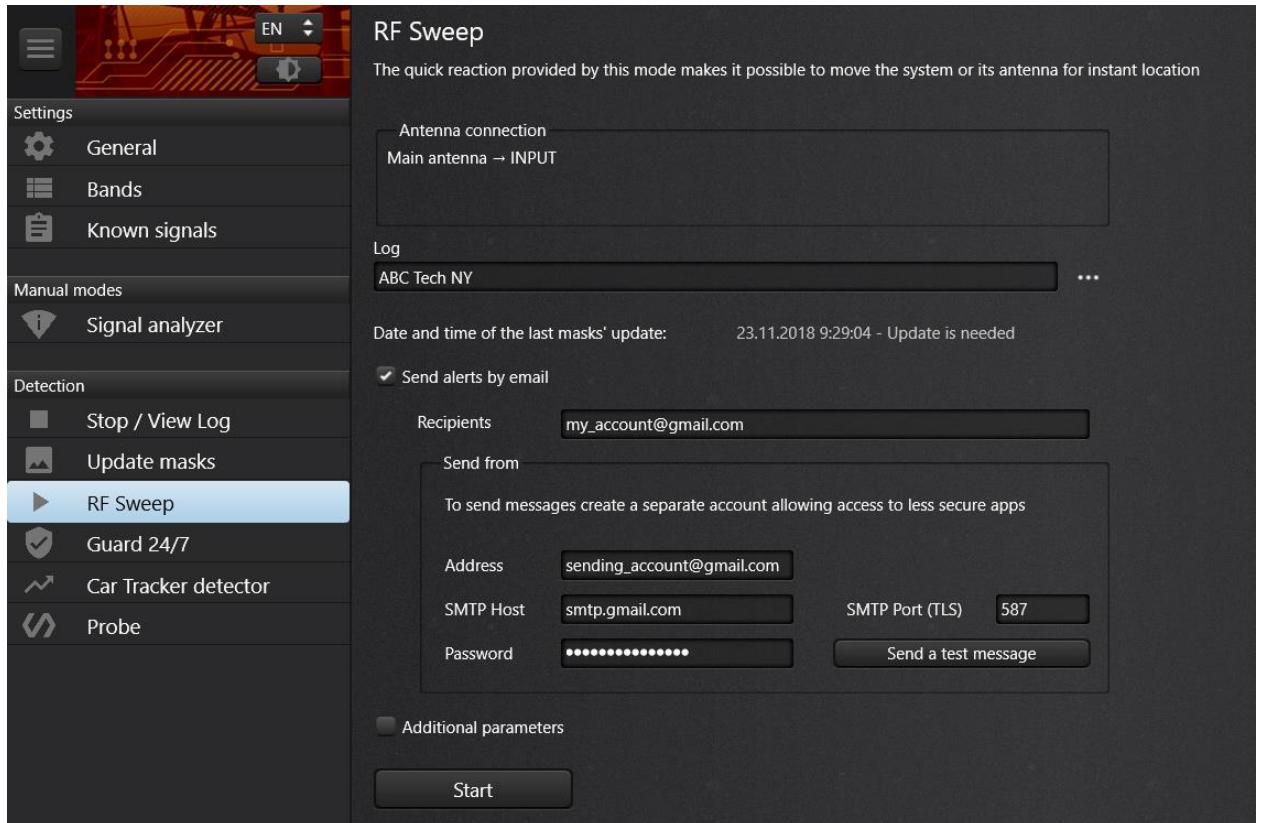

The "**Send alerts by email**" can be activated in the settings of the RF Sweep mode.

Some additional parameters must be entered:

Recipients – receiving email addresses (should be separated by ";" if more than one)

Send from | Address – sending email address

Send from | SMTP Host – name of the SMTP host (smtp.gmail.com for gmail)

Send from | SMTP Port – number of the SMTP ports supporting the TLS encryption (587 for gmail.com)

Send from | Password – password for sending account

Please note that the Delta X stores all entered parameters except the "Send from | Password". Saving the password is omitted for security reasons so it should be re-entered each time the Delta X is launched.

The entered parameters can be checked with the help of the "Send a test message" button. The specified recipients should receive a test message in a few seconds. If the message is not received, check the internet connection and entered parameters.

It is recommended to connect the Delta X computer to the internet via the Ethernet cable to avoid false alarms from the wireless signals.

Setting up remote access

It is possible to control the Delta X remotely using the Chrome Remote Desktop app. The remote device can be another Windows computer, iOS, or Android device.

Both the Delta X computer and the remote device should be logged in under the same google account.

1. Download and install the Chrome browser on the Delta X computer
2. Download the [Chrome Remote Desktop](#) app.
3. Next, open Chrome on your computer.
4. In the address bar at the top, type `chrome://apps`, and press Enter.
5. Click Chrome Remote Desktop .
6. Under "My Computers," click 'Get started'.
7. Click "Enable remote connections"
8. Enter a PIN, and then re-type the PIN. Click OK.
9. Click Yes to install the Chrome Remote Desktop service.
10. Confirm the Google Account and enter the PIN again to continue.

Download the Chrome Remote Desktop software onto the remote device from the Play Market (Android), App Store (iOS) or Chrome web store (Windows). Start the software. The computer you previously allowed (i.e. Delta X computer) should show up under "My Computers" on the remote device.

Advanced power settings

All laptops and tablets decrease the power consumption by limiting the processing power and putting the USB interface in a suspended mode periodically. This may cause slow or incorrect work of the Delta X system. The "Power Options" window allows the user to control the advanced power settings in order to disable the interfering power saving options:

- Right click the battery icon on the right bottom corner
- Click "Power Options" → "Change plan settings" → "Change advanced power settings"

Unfortunately, some important settings, such as the processor and USB control, might be hidden in the "Power Options" by default. The Registry Editor can be used to unhide the advanced power settings:

- 1) Run the Registry Editor as Administrator (type "regedit" in the command line, right-click the "Registry Editor" and select "Run as Administrator")
- 2) Open the following path:
`HKEY_LOCAL_MACHINE\System\CurrentControlSet\Control\Power\PowerSettings`

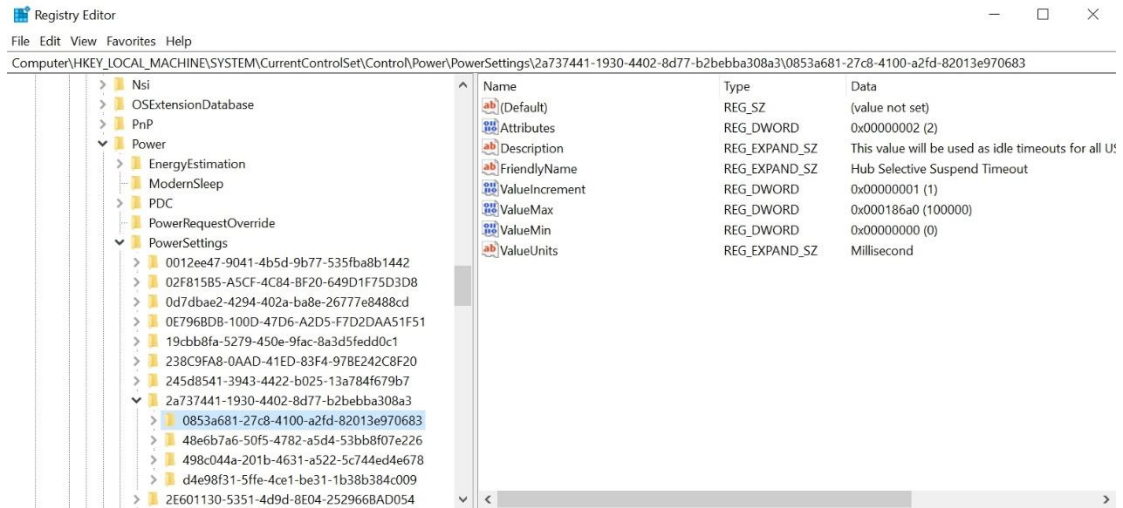

- 3) The path will contain a number of keys and sub-keys containing values responsible for advanced power settings. Look through the “Description” and “FriendlyName” values to understand the dedication of a key or sub-key.
- 4) Find important power settings, particularly having relation to the processing power and “USB suspend” mode. Turn on their visibility by settings the “Attributes” values as “2”.
- 5) Close the registry editor

Now open the “Power Options” window and change the advanced power settings:

- Disable and zero all USB-related power saving settings:
 - HUB Selective Suspend Timeout = 0
 - USB selective suspend setting = Disabled
 - USB 3 Link Power management = power saving off, etc.
- Disable and minimize all other power saving settings which can affect operation of the Delta X software, such as the processing power, etc.

Localizing the interface

The Delta X software can be localized to any language by creating the corresponding translation file.

The translation file should be placed in the application's folder (Usually C:\Program Files\DigiScan Labs\Delta X or C:\Program Files (x86)\DigiScan Labs\Delta X).

The translation file should have the following name: InterfaceXX.txt, where XX is the abbreviation for the language. For example, the translation file for Poland should have the name InterfacePL.txt.

The file must contain the translation strings in the following format:

Sentence in English1=Translated sentence1

Sentence in English2=Translated sentence2

...

The length of the translated sentence should not significantly exceed the original to avoid the concatenations. Use shortenings where necessary.

Below is the example of the translation file for Poland and the result:

Settings=Ustawienia
Calibration / Data=Kalibracja / Dane
Known signals=Znane sygnały
Manual modes=Tryby reczne
Wide-Range analyzer=Analizator Szerokozakresowy
Signal analyzer=Analizator sygnału
Detection=Wykrywanie
Stop / View Log=Stop / Widok bazy danych
RF Sweep=RF Poszukiwanie
Guard 24/7=Straz 24/7
Car Tracker detector=Wykrywanie lokalizatorow
LF Probe=LF Sonda
...

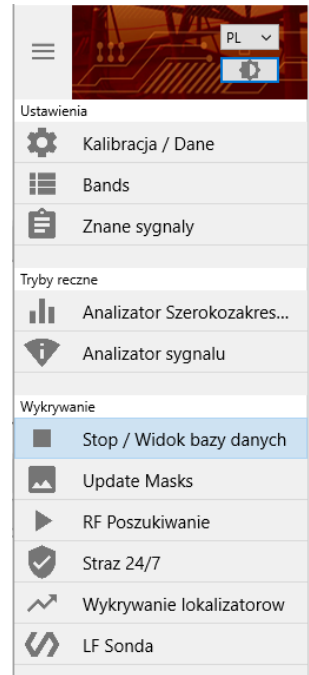

An already existent translation file can be found in the application's folder and used as a blank.